

07 April 2015

HERITAGE IMPACT ASSESSMENT

Hammond Reef Gold Project 23 km Northeast of the Town of Atikokan Thunder Bay Mining District Northwest Ontario

Submitted to:
Canadian Malartic Corporation
145 King Street East, Toronto, ON

REPORT



Report Number: 1408383_DOC005_Rev 1

Distribution:

1 e-copy - Canadian Malartic Corporation
2 Copies - Golder Associates Ltd.





HERITAGE IMPACT ASSESSMENT HAMMOND REEF GOLD PROJECT

Executive Summary

Golder Associates Ltd (Golder) was retained by the Canadian Malartic Corporation (Canadian Malartic) to undertake a Heritage Impact Assessment (HIA) of the proposed Hammond Reef Gold Project (the Project) located approximately 170 km northwest of Thunder Bay, Ontario. This HIA assessed the cultural heritage value of potential heritage resources located within the Project area and developed mitigation options to minimize adverse effects of the proposed undertaking. This HIA is required to address the cultural heritage environmental assessment components of the *Canadian Environmental Assessment Act* (CEAA) and the *Ontario Environmental Assessment Act* (OEAA). The HIA followed the methodology described in *Guidelines for Heritage Impact Assessments* (Ontario, Ministry of Culture *Heritage Resources in the Land Use Planning Process*).

The proposed Project is situated within the historic Upper Seine mining region. This region's gold resources were discovered in 1872 but significant prospecting did not occur until after completion of the Canadian Pacific Railway through the region in the 1880s. A number of small scale mining operations produced gold in between 1897 and 1903 including the Sawbill Mine and the historic Hammond Reef Mine within the study area. Both properties were shut down by the end of 1900. The Sawbill Mine property was reopened between 1937 and 1941 due to the rise in the price of gold during the Depression.

Golder field investigations in 2012 identified that a number of cultural features in Sawbill Mine property that related to both phases of the mine's operation including a stamp mill foundation, hoist engine, tramway, and mine shafts. The historic Hammond Reef mine property had been more disturbed over time than the Sawbill property and contained fewer historic mining related features.

This 2014 HIA determined that the Hammond and Sawbill Mines were properties of *Historical Value or Associative Value* according to O.Reg 9/06 Criteria. Both properties fit into the pattern of development for the first mining activity in northwestern Ontario. This HIA recommended that Canadian Malartic should undertake the following three activities:

- 1) Prior to any further mine development in the vicinity of the two historic mine sites, the properties should be photographically documented and mapped to illustrate the:
 - condition of the mine structures;
 - relationship of the structures to the surrounding setting/landscape;
 - technical details of any features that exhibit distinctive design characteristics; and
 - any additional features that were not identified during the archaeological survey.

This photo documentation should be undertaken under optimal environmental conditions (i.e. no snow cover, before/or after tree leafing, clear sky, appropriate sun/shadows, etc.) and accompanied with notes and sketch maps to assist in interpreting the photos. High-quality digital photography should be undertaken by qualified individual(s).



HERITAGE IMPACT ASSESSMENT HAMMOND REEF GOLD PROJECT

Copies of this photo documentation, this 2014 HIA, and any further site research or documentation undertaken by Canadian Malartic should be deposited with the:

- Atikokan Public Library;
 - Lakehead University Library; and
 - Other depositories to be determined.
- 2) The location of cultural resources for the historic Sawbill Mine site should be plotted, using data obtained during the documentation programme, as an environmental consideration for the Project. The historic resource map should identify the location of the historic physical resources so that their location can be considered as the design of the Project facilities is progressing. If possible, it is recommended that historic physical resources be left as monuments in the landscape after the Project has been completed.
- 3) An interpretation program should be developed as a partnership with identified local and regional institutions. In order to initiate this program, the Canadian Malartic Community Consultation Committee should define Canadian Malartic's commitment as follows:
- i) Identify community partners to work with to develop and manage an interpretation program
 - ii) Determine the company's financial commitment to an Interpretation Plan, specifically:
 - iii) Relocation of artifacts - cost of moving; stabilization
 - iv) Production of exhibit/interpretation materials
 - v) Define the company's long term corporate involvement in the Interpretation Plan

Since the initial draft of this HIA was prepared Canadian Malartic has completed follow-up studies to fulfill the recommendations provided in this HIA. These follow-up studies are appended to this HIA.



HERITAGE IMPACT ASSESSMENT HAMMOND REEF GOLD PROJECT

Table of Contents

1.0	STUDY PURPOSE AND METHOD	1
1.1	Study Purpose	1
1.2	Study Method	1
1.3	Metric Measurements	2
2.0	LAND USE HISTORY – GENERAL	5
2.1	Physical Setting	5
2.1.1	Seine River System	5
2.1.2	Topography/Vegetation	7
2.2	Settlement	7
2.3	Transportation	8
3.0	SAWBILL AND HAMMOND REEF MINES	13
3.1	Upper Seine Mining Region	13
3.2	Sawbill Mine Property	14
3.3	Hammond Reef Property	19
4.0	SUMMARY	22
5.0	STUDY AREA INVENTORY	22
5.1	Sawbill Mine	22
5.1.1	Mine Shafts	22
5.1.2	Stamp Mill Foundation	24
5.1.3	Engine	27
5.1.4	Tramway	29
5.1.5	Prospecting Trenches and Ore Pits	32
5.2	Hammond Reef Mine	34
5.2.1	Adit	34
5.2.2	Dam	35
5.2.3	Trenches and Pits	39
5.3	Other Sites	40
5.4	Cultural Heritage Landscapes	40



HERITAGE IMPACT ASSESSMENT HAMMOND REEF GOLD PROJECT

6.0 CULTURAL HERITAGE VALUE	41
6.1 Method of Evaluation	41
6.1.1 Regulation 9/06 Evaluation	41
6.1.2 Regulation 10/06 Evaluation	42
6.2 Statement of Cultural Heritage Value	42
7.0 POTENTIAL IMPACTS AND MITIGATION	44
7.1 Proposed Undertaking	44
7.2 Potential Impacts	44
7.3 Potential Mitigation	44
7.3.1 Documentation	44
7.3.2 Protection	45
7.3.3 Interpretation Plan	45
8.0 RECOMMENDATIONS	45
8.1 Documentation Programme	45
8.2 Protection Plan	46
8.3 Interpretation Plan	46
9.0 FOLLOW-UP WORK COMPLETED	46
10.0 SOURCES	47
10.1 Government Documents	47
10.2 Secondary Sources	47
10.3 Electronic Sources	47
11.0 CLOSURE	47
MAPS	
Map 1: Project Location	3
Map 2: Study Area	4
Map 3: Location of Heritage Resources	43



HERITAGE IMPACT ASSESSMENT HAMMOND REEF GOLD PROJECT

FIGURES

Figure 1: Ontario and Minnesota Power Company's plant, head of Falls Bay, Steeprock Lake. (Ont Dept of Mines, Geology and Ore Deposits of the Atikokan Area, 1939).....	6
Figure 2: Ontario Department Of Mines Annual Report 1921 Part 2, "Ontario Gold Deposits Their Character, Distribution and Productiveness" by Percy E. Hopkins.....	10
Figure 3: Portion of Map Showing Sawbill Lake to Atikokan River.....	11
Figure 4: Portion of Claims Map for Sawbill Lake Area.....	12
Figure 5: Advertisement for the Hammond Property.....	15
Figure 6: Sawbill 1896 (Ontario Bureau of Mines Report).....	16
Figure 7: Ontario Department of Mines Annual Report 1921, Part 2 (Ontario Gold Deposits Their Character, Distribution and Productiveness by Percy E. Hopkins) This vertical section of the mine was originally published in the 1900 Annual Report.....	16
Figure 8: No. 2 shaft, Elizabeth Mine, in 1937. It is assumed that the Sawbill Mine property would be of a similar character.....	17
Figure 9: Geology of the Sawbill Mine. Ontario Ministry of Natural Resources. Ontario Geological Survey. Mineral Deposits Circular 24, Gold Deposits of the Atikokan Area by S.J. Wilkinson, 1982.....	18
Figure 10: Hammond Reef Mine - Mill House - What Appears to be Aerial Tramway on Roof.....	20
Figure 11: Geology of the Hammond Reef Mine. Ontario Ministry of Natural Resources. Ontario Geological Survey. Mineral Deposits Circular 24, Gold Deposits of the Atikokan Area by S.J. Wilkinson, 1982.....	21
Figure 12: Main Shaft and Air Shaft from First Operation of the Mine (View Northeast).....	23
Figure 13: Main Shaft of Sawbill Mine (View North).....	24
Figure 14: Northwest Corner of the Stamp Mill Foundation Looking along the South Wall of the Structure (View West).....	25
Figure 15: View of the Interior of the Structure from the Northwest Corner of the Stamp Mill Foundation (View South).....	25
Figure 16: View of Southeast Corner of the Stamp Mill (View West).....	26
Figure 17: View of Concrete Pedestals in the Central Area of the Stamp Mill (View West).....	26
Figure 18: Concrete Tank to Right of the Concrete Slab in Northeast Portion of Stamp Mill Foundation (View East).....	27
Figure 19: Engine Orientated North-South (View Northwest).....	28
Figure 20: South End of the Engine with Imperial Keighley Marking Visible (View North).....	28
Figure 21: Flywheel of Engine on West Side of the Engine (View Northwest).....	29
Figure 22: View on Top of the Tramway near the Stamp Mill (View Northwest).....	30
Figure 23: Close-up of the Base of the Tramway (View South).....	30
Figure 24: Tramway Abutment for Crossing of a Creek (View Southeast).....	31
Figure 25: View of the Side of the Tramway from Concrete Slab West of the Tramway (View North).....	31
Figure 26: Tramway with Thin Base Mostly Seen as a Ditch in the Centre of the Photograph (View Northwest).....	32
Figure 27: Surface Trench along the William Vein (View Northeast).....	33
Figure 28: Surface Trench near Sawbill mine (View Southwest).....	33
Figure 29: Adit for the Original Hammond Reef Mine (View North).....	34



HERITAGE IMPACT ASSESSMENT HAMMOND REEF GOLD PROJECT

Figure 30: Drive Wheel for Engine Found in Front of Hammond Reef Adit (View Northwest).....	35
Figure 31: Timber Crib Dam Structure along Secondary Channel in Stream Valley (View West).....	36
Figure 32: Close up of Timber Crib Dam Structure (View North)	37
Figure 33: Former Head Pond above the Timber Crib and Waste Rock Dams; now Silted In. (View East)	38
Figure 34: Two Channels from Head Pond, Smaller Channel with Timber Dam to the Right (View East)	38
Figure 35: Waste Rock Dam Blocking Main Channel of the Head Pond (View southeast)	39
Figure 36: Large Open Pit Associated with the Original Hammond Reef Mine (View Northeast).....	40

APPENDICES

APPENDIX A

Hammond Reef Heritage Photographic Documentation

APPENDIX B

Options for Mitigation of Heritage Impacts



HERITAGE IMPACT ASSESSMENT HAMMOND REEF GOLD PROJECT

1.0 STUDY PURPOSE AND METHOD

1.1 Study Purpose

Golder Associates Ltd. (Golder) was retained by the Canadian Malartic Corporation (Canadian Malartic) to undertake a Heritage Impact Assessment (HIA) of the proposed Hammond Reef Gold Project (the Project). This HIA assessed the cultural heritage value of potential heritage resources located within the Project area and developed mitigation options to minimize adverse effects of the proposed undertaking.

The Property is located within the Rainy River District in northwestern Ontario. The property is approximately 170 km west of Thunder Bay, Ontario (Map 1). The Project consists of the development of an open pit mine and associated ore processing facility and tailings management area, upgrading of an access road to the property, and construction of a new electrical transmission line (Map 2).

This HIA meets the cultural heritage environmental assessment components of the *Canadian Environmental Assessment Act* (CEAA) and the *Ontario Environmental Assessment Act* (OEAA). The CEAA requirements are defined in the *Canadian Environmental Assessment Agency Reference Guide on Physical and Cultural Heritage Resources* (1996) and the OEAA requirements are defined in the Ontario Ministry of the Environment *Guidelines for Preparing the Cultural heritage Resource Component of Environmental Assessments* (1992).

1.2 Study Method

The Project is located on the shore of Sawbill Bay, an extension of Marmion Reservoir and approximately 23 km northeast of the town of Atikokan. This HIA defined the study area as including the Mine Study Area containing the mine infrastructure, and a larger Regional Study Area that includes the area of mining impacts plus areas in which historic gold mining development associated with local area occurred.

In a letter, March 7, 2014, from Penny Young, Ministry of Tourism Culture and Sport (MTCS), Heritage Planner, Culture Services Unit, to Michelle Whitmore, Ministry of the Environment Special Projects Officer, Ms. Young noted:

In Version 2 of the [revised Hammond Reef Project] “Cultural Heritage Resources TSD” dated December 2013, Part A indicates that Part B the Supplemental Information Package “provides an updated report related to the Cultural Heritage Resources Component.” Part B is a “Stage 1 Baseline Study and Stage 2 Archaeological Assessment” and there is no mention of the HIA recommendation within the Version 2 TSD nor is a completed HIA included.

The document states that the two historic mining operations are to be evaluated through a CHER at a later date. However, in order for the proponent to meet the commitment to identify and consider archaeological resources, built heritage resources and cultural heritage landscapes as part of the EIS/EA process, a CHER and HIA should be prepared as part of this EA submission.

This Golder HIA was undertaken to address the MTCS recommendation. The Cultural Heritage Evaluation Report (CHER) and the Heritage Impact Assessment (HIA) have been combined as a single HIA document. A CHER determines whether a property is of cultural heritage value. If the property is determined to be of cultural heritage value, the report concludes with a Statement of Cultural Heritage Value. If the property will be impacted by new development a recommendation is made to prepare an HIA. An HIA includes all of the information and



HERITAGE IMPACT ASSESSMENT HAMMOND REEF GOLD PROJECT

analysis required to prepare a CHER plus a description of the proposed undertaking, its impacts on the cultural resource, and recommendations for mitigation of adverse impacts to the cultural resource.

The HIA followed the methodology described in *Guidelines for Heritage Impact Assessments* (Ontario. Ministry of Culture, *Toolkit: Heritage Resources in the Land Use Planning Process*). The interpretation of the properties was also guided by the United States National Register of Historic Places *Bulletin #42, Guidelines for Identifying, Evaluating and Registering Historic Mining Properties*.

The following study approach was used:

- A thematic land-use history of human activities in Sections 2-4 of this report was prepared to guide the inventory process and provide a historical context for evaluating the significance of identified cultural resources. The land use history was researched using published reports, historic maps, and archival sources.
- Section 5 contains the findings of the archaeological survey of the Project Area undertaken by Golder between July 18, 2012 and August 7, 2012 and used to identify potential cultural resources for this HIA.
- Section 6 evaluated the cultural value of built heritage resources identified through the Land use History and archaeological Field Work, using *Ontario Heritage Act* Regulations 9/06 and 10/06.
- Section 7 described the potential impacts of the undertaking and identified potential mitigation options
- Section 8 recommends the preferred mitigation of adverse effects.

Section 9 summarizes the follow up work completed by Canadian Malartic based on the recommendations provided in Section 8.

1.3 Metric Measurements

In 1971, Canada adopted the metric system; however, all structural dimensions in this text are given in Imperial units. In general, the use of Imperial rather than metric is preferred for describing historic structures. Engineered structures were built to standard Imperial dimensions and distinctive patterns within such structures can be obscured by converting the original Imperial into metric units.

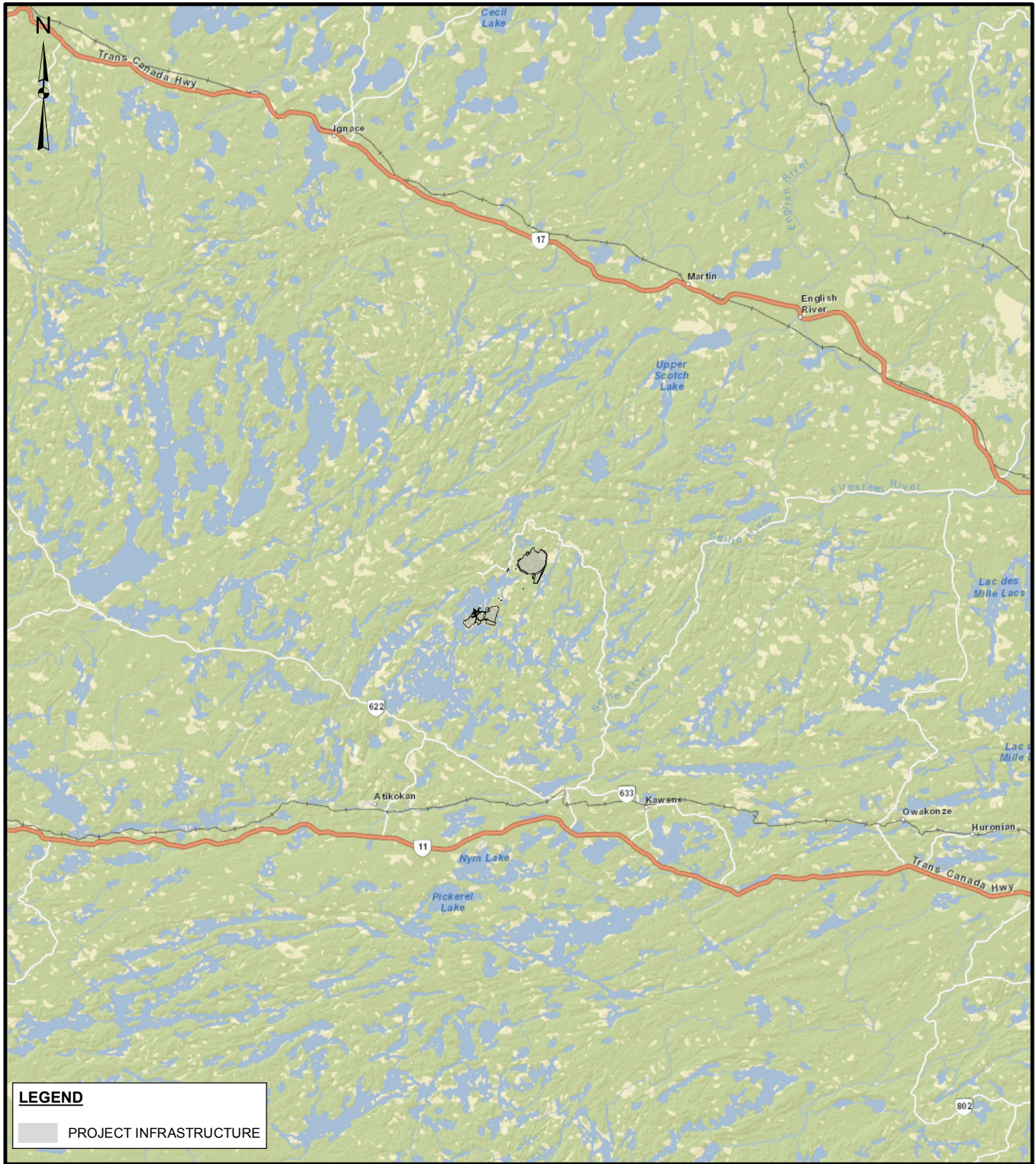

LEGEND

PROJECT INFRASTRUCTURE

REFERENCE

BASE DATA - PROVIDED BY OSISKO HAMMOND REEF GOLD PROJECT LTD.;
 SOURCES: ESRI, HERE, DELORME, USGS, INTERMAP, INCREMENT P CORP., NRCAN, ESRI JAPAN, METI, ESRI CHINA (HONG KONG), ESRI (THAILAND), TOMTOM, MAPMYINDIA, © OPENSTREETMAP CONTRIBUTORS, AND THE GIS USER COMMUNITY
 PROJECTION: TRANSVERSE MERCATOR DATUM: NAD 83 COORDINATE SYSTEM: UTM ZONE 15N

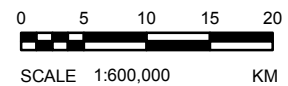

DATE	2014-05-28
DESIGN	CP
GIS	BR

TITLE	PROJECT LOCATION	
PROJECT		
MAP 1		

PROJECT No.	13-1118-0010-5006
SCALE	AS SHOWN
VERSION 2	REVIEW

Document Path: N:\Active\Spatial\IM\OsiskoHammondReefGold\HammondReefGoldProject\99 - PROJ\131118001040 - PROJ\5006\1311180010-5006-01.mxd

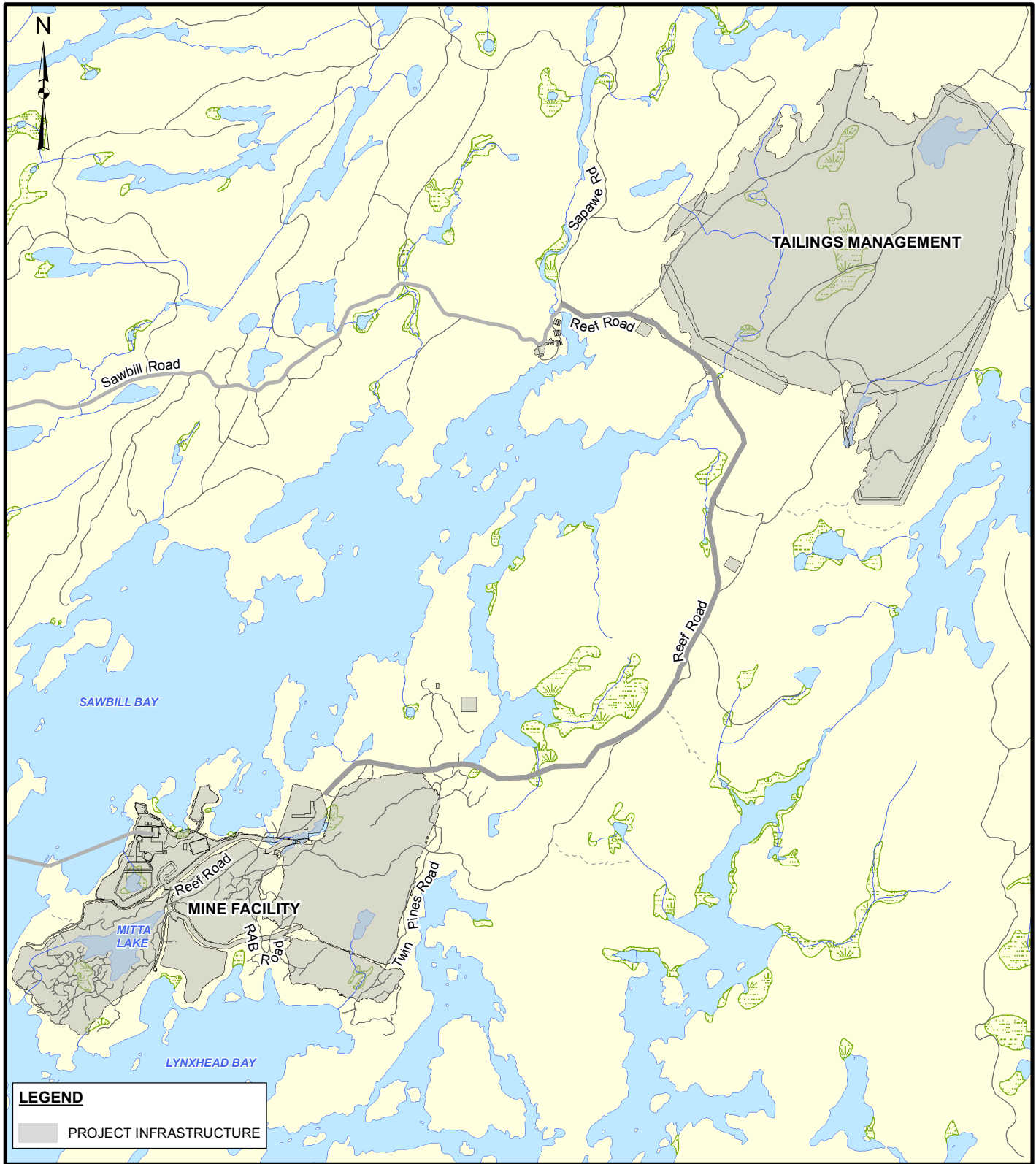

REFERENCE

BASE DATA - PROVIDED BY OSISKO HAMMOND REEF GOLD PROJECT LTD.;
 BASE DATA - MNR NRVIS, OBTAINED 2004. PRODUCED BY GOLDR ASSOCIATES LTD
 UNDER LICENCE FROM ONTARIO MINISTRY OF NATURAL RESOURCES, © QUEENS PRINTER 2012
 PROJECTION: TRANSVERSE MERCATOR DATUM: NAD 83 COORDINATE SYSTEM: UTM ZONE 15N

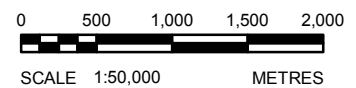

DATE	2014-05-28
DESIGN	CP
GIS	BR

STUDY AREA

PROJECT No. 13-1118-0010-5006

SCALE AS SHOWN

VERSION 2

CHECK
 REVIEW

PROJECT HAMMOND REEF GOLD PROJECT
 ATIKOKAN, ONTARIO, CANADA

MAP 2



HERITAGE IMPACT ASSESSMENT HAMMOND REEF GOLD PROJECT

2.0 LAND USE HISTORY – GENERAL

2.1 Physical Setting

2.1.1 Seine River System

The *Seine River* extends from Lac des Mille Lacs in the east to Rainy River in the west. Water from Rainy Lake passes through the Lake of the Woods, Lake Winnipeg and the Nelson River and flows into Hudson Bay. The river's course was significantly altered in the 1940s due to the opening of the Steeprock iron mine. This resulted in the blocking of the natural course between Marmion Reservoir and Steeprock Lake and re-routing the flow through Finlayson Lake.

Sawbill Bay is a northern extension of *Marmion Reservoir* and they form part of the Seine river chain of lakes and connecting stretches of flowing water. Before *Marmion Reservoir* was created, it was known as *Sawbill*. The Bay is about eight kilometres long. In 1896, it was described as *a fine sheet of water, with few islands and mostly wooded shores, some handsome groves of pine giving beauty to the area.*¹

Marmion Reservoir is an artificial lake created by flooding from a dam constructed in 1926 by the Ontario and Minnesota Power Company as part of a hydroelectric power development known as the Moose Generating Station. Previously a much smaller lake, Moose Lake, was part of an interconnected system of lakes on the Seine River that included Sawbill Lake and an outflow to *Steeprock Lake*. The control dam raised the water level by about 55 feet to flooding out the connecting channels moved the shoreline back in places as much as a half kilometre. The timber was not cut from the shores of Marmion Reservoir before the water was raised, and this created a maze of dead trees and islands in the new reservoir and created navigation hazards to those using the reservoir.²

Steeprock Lake was considered an unusually beautiful body of water because of its high rocky shores, from which it got its name, and the steep red bluffs of oxidized carbonate so prominent around the north shore. By the 1930s residents of Atikokan had constructed a number of summer cottages on the lake. In 1943, the flow of the Seine River was diverted from its natural channel between Marmion Reservoir and Steeprock Lake through artificial channels between these two lakes in order to mine the vast iron ore deposit beneath Steeprock Lake. The Moose Generating Station was decommissioned and the discharge channel from Marmion Reservoir was blocked.

Finlayson Lake was extensively altered as a result of the Steeprock river diversions. Historically, Finlayson Lake (known as *Clearwater Lake* until the early 20th century) flowed into Sawbill Bay through a stream and small lake called Raft Lake. Finlayson (Clearwater Lake) was described in 1896 as the water: “...being transparent as crystal and almost alarming to the canoeman familiar with the turbid waters of the Seine. Every rock and snag shows distinctly and one expects to run aground.”

¹ Bureau of Mines, *Annual Report, 1896.* “Third Report on The West Ontario Gold Region,”

² Seine River Watershed Information - seineriverwmp.com/history.html; Ont Dept of Mines, Geology and Ore Deposits of the Atikokan Area, 1939; Ont MNR Fenwick Geology of the Finlayson Lake Area 1976.



HERITAGE IMPACT ASSESSMENT HAMMOND REEF GOLD PROJECT

In 1900, water power on the creek, between Clearwater Lake into Sawbill Bay, was utilized to power a generating station to supply the Hammond Reef Mine. Three timber-crib dams were constructed, and a 700 foot-long, five foot-diameter timber penstock delivered water from a 50 foot head to two turbines coupled to a single generator.³

The Steeprock Diversion reversed the flow between Finlayson Lake and Marmion Reservoir, by lowering the Finlayson Lake water level below that of the reservoir. A new exit channel at the south end of the lake flowed back into the remnant of Steeprock Lake and the Seine River. Lowering Finlayson Lake exposed up to three-quarters of a kilometer of former lake bottom.⁴

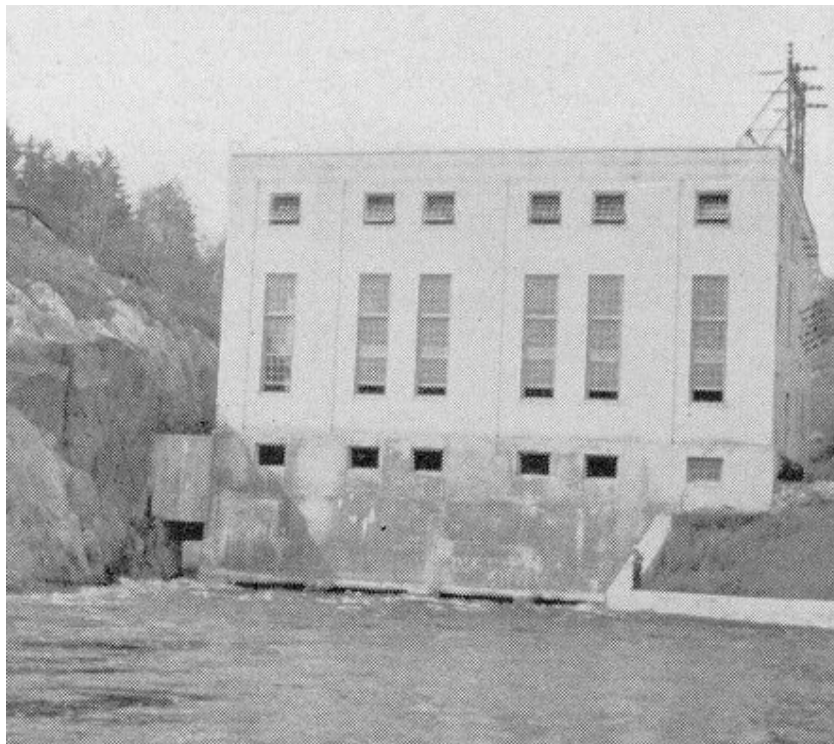

Figure 1: Ontario and Minnesota Power Company's plant, head of Falls Bay, Steeprock Lake. (Ont Dept of Mines, Geology and Ore Deposits of the Atikokan Area, 1939)

³ Bureau Of Mines, *Annual Report*, 1896, "Third Report on The West Ontario Gold Region" *Annual Report*, 1900; Ontario Dept. of Mines *Geology and Ore Deposits of the Atikokan Area*, by E. S. Moore, 1939

⁴ Ont MNR Fenwick *Geology of the Finlayson Lake Area* 1976



HERITAGE IMPACT ASSESSMENT HAMMOND REEF GOLD PROJECT

Atikokan River flows westward through the Town of Atikokan and connects with the Seine River south of Steeprock Lake. The river was navigable for small craft as far as Steeprock Lake. The Atikokan River, in contrast to the Seine, has a fairly wide flood plain and meanders through an alluvial, swampy plain in which there are few exposures of bed rock.⁵

2.1.2 Topography/Vegetation

The topography of the area is typical of Precambrian Shield terrain and present as rocky hills alternating with lakes, marshes and drift-covered lowlands. The granitic areas to the east and west present a more rolling surface. The present topography appears to be the result of a combination of structural control and glaciation. The end moraine at the south end of Finlayson Lake and Marmion Reservoir is perpendicular to the northeasterly trending lineaments. Therefore, the glacier flowed down the structural troughs. The bedrock elevation varies from 1,600 feet (490 m) above mean sea level in the northwestern part of the map-area to 1,400 feet (430 m) in the northeastern part of the map-area. There are prominent hills around the lakes, but the topography is not so rugged as along the Seine River valley.⁶

The dominant vegetation in the Project location is a combination of coniferous and mixed forests with coniferous forests dominant in the western portion of the ecoregion. Characteristic species of the coniferous forests are white spruce, balsam fir, and eastern white pine. Subdominant species include trembling aspen, paper birch, and jack pine, whereas poorly drained sites are characterized by black and white spruce, balsam fir, tamarack, eastern red cedar, and willow.⁷

Forest cover throughout the region has been directly influenced by the timber industry and also an increase in forest fires due to settlement and railway traffic. Forest fires have the effect of further degrading any thin soils, while also allowing the establishment of more vigorous pioneer species such as trembling aspen and balsam fir. This sequence of tree cover replacement is also encountered after the disturbance of logging operations. Without disturbance, natural or man-made, black spruce forest dominates the upland areas of the region.⁸

The area at one time supported a good stand of pine, but this has been nearly all cut. In 1903 and 1904, large fires swept away most of the timber, but the northern part is now covered with second growth, which has reached sufficient size in many parts to provide some good stands of red pine, spruce, and jackpine.⁹

2.2 Settlement

In 1821, the Hudson's Bay Company and the North West Company amalgamated to reduce competition in the fur trade. At the beginning of the 19th century, the Hudson's Bay Company shifted its focus towards western Canada and gradually closed its trading posts in northern Ontario. Between 1774 and 1821, there were over 600 posts, most of them only being occupied for a few years; by 1825 only 45 existed. By the mid-19th century, no trading posts were located within the vicinity of the Project area.¹⁰

⁵ Ontario Dept of Mines *Geology and Ore Deposits of the Atikokan Area*, by E. S. Moore, 1939

⁶ Ont MNR Fenwick *Geology of the Finlayson Lake Area 1976*; Ontario Dept of Mines *Geology and Ore Deposits of the Atikokan Area*, by E. S. Moore, 1939.

⁷ Ecological Stratification Working Group 1996:66.

⁸ Golder Associates. "Stage 1 Baseline Study And Stage 2 Archaeological Assessment, Osisko Hammond Reef Gold Project, Ontario, Canada" Report 10-1118-0020-9200, May 22, 2013.

⁹ Ontario Dept. of Mines *Geology and Ore Deposits of the Atikokan Area*, by E. S. Moore, 1939.

¹⁰ Golder Associates "Stage 1 Baseline Study" 2013.



HERITAGE IMPACT ASSESSMENT HAMMOND REEF GOLD PROJECT

Treaty-making with the First Nations in Ontario generally started in the south, moving north as European settlement expanded. Accessibility to the area due to construction of the Canadian Pacific Railway through northwestern Ontario in the 1880s, was a driving force to the treaty signing. The location of the proposed Hammond Reef Gold Mine study area is located within lands that were originally part of the 1873 Treaty Number 3. When geologists of the Ontario Bureau of Mines were on Sawbill Lake in the summer of 1896, they noted an Indian encampment on the shore.¹¹ Today, the closest Aboriginal community is the Lac des Mille Lacs First Nation, approximately 40 km to the east.

The Rainy River was created in 1885.¹² The town of Atikokan approximately 180 km northwest of Thunder Bay is the closest community to the study area. A prospector, Tom Rawn, settled in the Atikokan area about the time the Canadian National Railway was completed through the area in 1899. He staked a claim for iron ore in the Steep Rock area. He is considered the first non-aboriginal Atikokan resident and opened the first local hotel in 1900. That same year a general store opened and in 1906, a sawmill began operations¹³. Although the town grew modestly supporting the many small gold and iron mining ventures in the early 20th century, it did not see significant growth until the opening of the Steep Rock Iron Mines in the 1940s. Throughout its history, in addition to mining, significant lumber and pulp developments existed initially to supply the mines and early town-building, but later expanded as an export industry.

2.3 Transportation

Until completion of the Canadian Pacific Railway (CPR) in 1882, the main route of travel wagon across northwestern Ontario was by means of the Dawson Road. This combination of water and road route was completed in 1870 and extended from Fort William by way of Lac des Mille Lacs and Sturgeon Lake to Rainy Lake.¹⁴

This chain of waterways was south of the Seine River. The Seine River also started at Lac des Mille Lacs and later provided the main means of access to the future mining areas along the Upper and Lower Seine River.

Completion of the CPR between Fort William and Winnipeg in 1882 greatly improved access into northwestern Ontario.¹⁵ Two water routes starting at railway stations were used to reach the Upper Seine Mining region. One route, starting at the Savanne station, was described in 1896 by a geological party from the Ontario Bureau of Mines. They left Toronto on June 27 by the CPR for Fort William. After purchasing supplies and securing canoemen, they took the train to Savanne, at the north end of Lac des Mille Lacs. They left Savanne on July 4 and reached Sawbill Lake on July 8. Later, they continued down the lower Seine River and reached Fort Francis on July 23.¹⁶

The other way to reach the Upper Seine mining district, and apparently the preferred way to Sawbill Lake, was from Bonheur station, further northwest on the CPR near Ignace. This was a water route in the summer and

¹¹ Golder Associates "Stage 1 Baseline Study" 2013; Bureau Of Mines, *Annual Report*, 1896."Third Report on The West Ontario Gold Region,"

¹² A District is a statutory, but unincorporated, subdivision of provincial province to deliver judicial and provincial government services to sparsely populated areas and, more recently, certain social services. The boundaries of a federal census division may correspond to those of a district.

¹³ Golder Associates "Stage 1 Baseline Study" 2013.

¹⁴ GSC *Geology Of The Area Covered By The Seine River . . . Map-Sheets*. By William: McInnes, 1899

¹⁵ The track actually reached Lac des Mille Lacs in 1879.

¹⁶ Bureau of Mines, *Annual Report*, 1896."Third Report on The West Ontario Gold Region,"



HERITAGE IMPACT ASSESSMENT HAMMOND REEF GOLD PROJECT

maintained as a sleigh road leads in winter. The travel distance from Bonheur to Sawbill Lake was about 30 miles (or 33 miles) and involved 13 portages, including a two mile portage at Bonheur.¹⁷

The Bonheur winter road was adequate for “normal” traffic. A stage line ran three days a week to Sawbill Lake. However, the route was challenging for heavy loads. The Hammond Reef mine needed a five-ton generator brought to Clearwater Lake to provide electric power for its mine. The road’s bad condition posed serious (unspecified) haulage problems.¹⁸

In 1902, the Canadian Northern Railway (today part of the Canadian National) completed a line from Port Arthur to Winnipeg by way of the Town of Atikokan. The mine site could be reached from Atikokan by water in the summer, and by a 27-mile road in the winter.¹⁹

Transportation, especially rail service, was a limiting factor to the success of mining in the Upper Seine River area. In 1900, the Ontario Bureau of Mines commented that:

*Considering the inaccessibility of most of the properties in this locality, it would hardly be expected that mining would be carried on to the extent to which it is. The new railway will, however, help matters in this respect to a considerable extent.*²⁰

¹⁷ Bureau of Mines, *Annual Report*, 1896. “Third Report on The West Ontario Gold Region

¹⁸ Bureau of Mines *Annual Report* 1900

¹⁹ Dept of Mines, *Annual Report*, 1939, Part 1,

²⁰ Bureau of Mines *Annual Report* 1900



HERITAGE IMPACT ASSESSMENT HAMMOND REEF GOLD PROJECT

To accompany Report by P. E. Hopkins in Vol. XXX, Part 2, Ontario Department of Mines Report, 1721

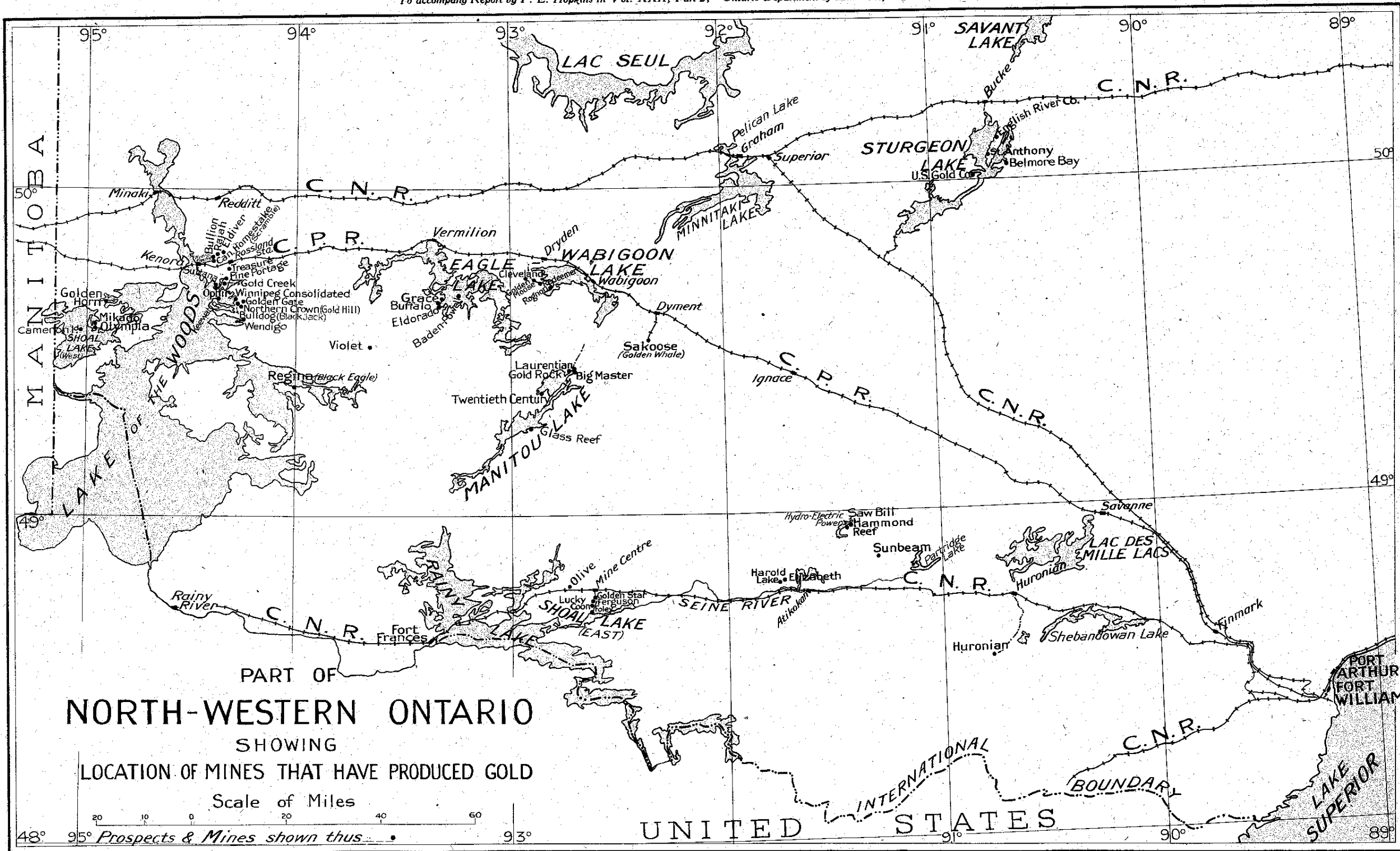
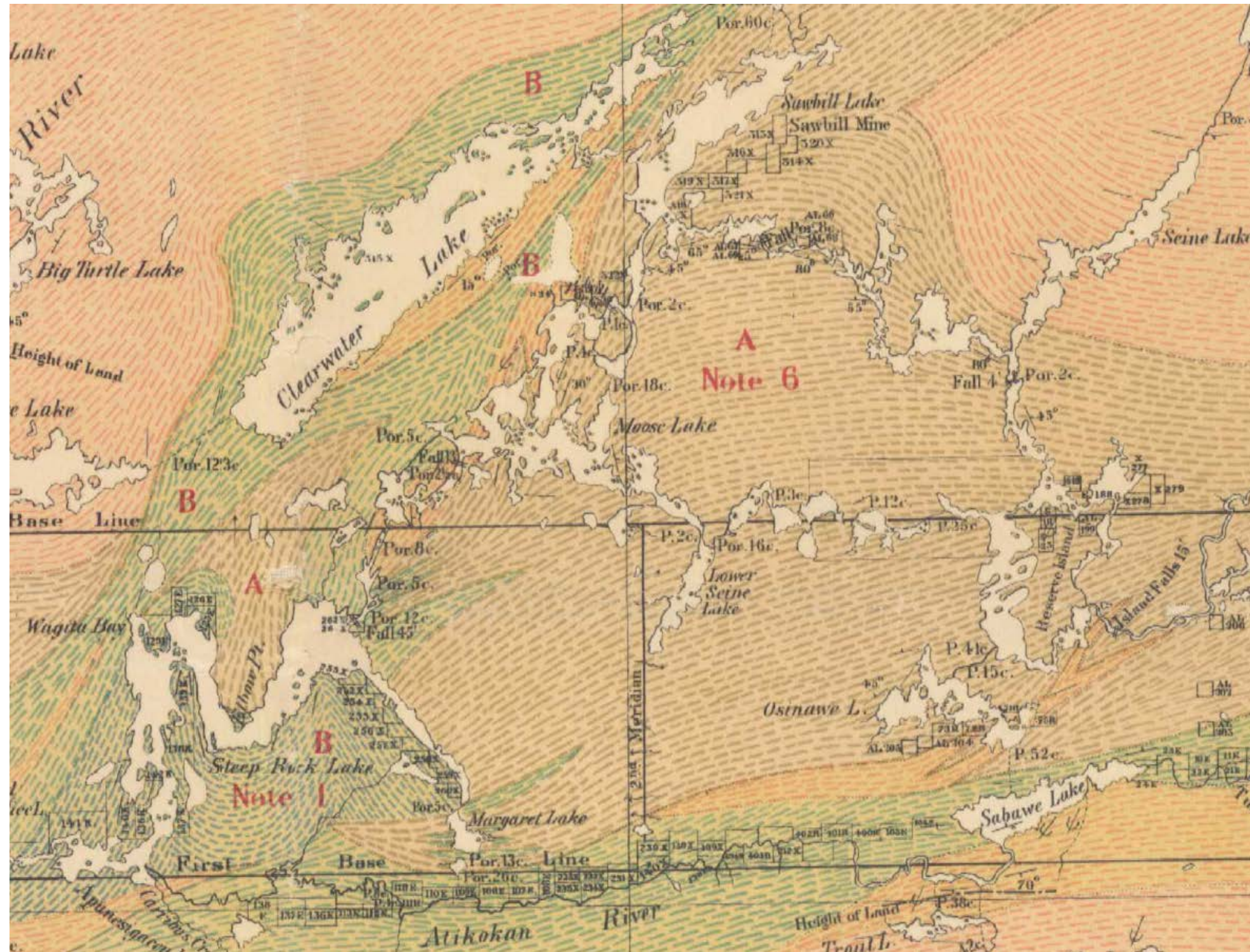

Figure 2: Ontario Department Of Mines Annual Report 1921 Part 2, "Ontario Gold Deposits Their Character, Distribution and Productiveness" by Percy E. Hopkins



HERITAGE IMPACT ASSESSMENT HAMMOND REEF GOLD PROJECT



Source: Canada Geological Survey, 1899.

Figure 3: Portion of Map Showing Sawbill Lake to Atikokan River.



HERITAGE IMPACT ASSESSMENT HAMMOND REEF GOLD PROJECT

3.0 SAWBILL AND HAMMOND REEF MINES

3.1 Upper Seine Mining Region

The first recorded discovery of gold-bearing veins along the Seine River seems to have been at Partridge Lake, where, in 1872, Archibald McKellar located several large veins of quartz which proved to contain gold. No development work any consequence occurred at that time. The discovery of gold near the mouth of the Seine River in 1893, that prospecting began to be carried on actively in the Seine River country. Since that time the Keewatin band in which the valley of the river lies, has been explored in a desultory way throughout almost its whole length. A great number of locations have been taken up, and a large amount of development work has been done.²¹

The Ontario Bureau of Mines described the gold mines on the Seine River as two groups; the Upper and Lower Seine Mining Regions: The Lower Seine Mining Region consisted of a cluster of mines in the vicinity of Shoal Lake. Upper Seine Mining Region included the Hammond Reef and Sawbill (later Upper Seine Gold) Mines. In addition to these two properties three other mines – Elizabeth, Harold Lake, and Sunbeam had also produced some gold up to the 1940s. None were big producers; the most productive mine, Sawbill had produced \$21,785 of gold by 1942. The Harold Lake mine was the first worked gold mine on the Seine River. It consisted of a five-stamp mill and operated during 1895-96; the mine was closed by 1901. The Sunbeam, obtained a 10-stamp mill erected in 1904, but the mine had closed by early 1905. The Elizabeth (FM. 171, FM. 172) was discovered in 1900, and before it closed, in 1903, a 10-stamp mill had been erected. The mine was re-opened worked in 1912, 1913, and 1914.²²

This Upper Seine Mining Region had attracted the attention of prospectors since about 1890, and several discoveries were made and shafts sunk before the close of the century. These properties were all worked for gold. However, the iron deposits around Atikokan ultimately became the largest and most profitable mining activities. Prospectors were aware of the iron potential since at least 1882. Development of the major deposit at Steeprock Lake did not begin until an active drilling programme in 1938 revealed the extent of the deposit.²³

Several other properties were developed in the vicinity of the Hammond and Sawbill mines. On Finlayson (Clearwater) Lake the Clearwater Gold Mining Company was located on claim X.78. Two shafts and an adit were developed.²⁴ The mine was apparently closed in 1901.

A small mine, referred to as the Connolly property, operated on a small island in Marmion Reservoir near the entrance to the northwest bay. Ore was removed from a small pit and transported by tram to a little mill. The mine was not in operation in 1939. In 1900 the Duluth Mining Company of Ontario Limited, operated two shallow shafts a few miles north of Sawbill.²⁵

²¹ GSC *Geology of the Area Covered by The Seine River; Map-Sheets*. By William McInnes, 1899

²² Ibid.; Dept. of Mines *Annual Report* 1921 Part 2, "Ontario Gold Deposits Their Character, Distribution and Productiveness" by Percy E. Hopkins; Dept of Mines *Annual Report*, 1942, Part 1 Mines in Ontario p.209-103. Ont. Ministry of Natural Resources *Geology of the Finlayson Lake Area* Fenwick 1976; Dept. of Mines, Geology and Ore Deposits of the Atikokan Area, 1939.

²³ Dept. of Mines, *Geology and Ore Deposits of the Atikokan Area*, 1939

²⁴ An adit is a horizontal passage driven from the surface for working a mine.

²⁵ *Bureau of Mines Report* 1900; Ont. Dept. of Mines, Geology and Ore Deposits of the Atikokan Area, 1939.



HERITAGE IMPACT ASSESSMENT HAMMOND REEF GOLD PROJECT

3.2 Sawbill Mine Property

Sawbill mine, on Claims 313X and 314X, was situated near the eastern shore of Sawbill Lake, an expansion of the Seine River north of Moose Lake. The ore potential was visible as a quartz vein four to six feet wide. A 10-stamp mill was erected and commenced operation in October, 1897, but very little gold was recovered. The property has remained idle since the autumn of 1897.²⁶

The property is first mentioned in an Ontario Government report in 1895, where it is remarked that the Wiley brothers had discovered a vein on Sawbill Lake. The Sawbill Lake Gold Mining Company, Limited was incorporated in May 1896. The Company owned mining locations 313X and 314X with the mine on 313X. Work was begun in April, 1895 and at the end of 1896 'the main shaft had been sunk 145 feet. At 60 feet, a level was cut south along the vein. A second level was run at 120 feet. All supplies and machinery were brought in from Bonheur station on the CPR.²⁷

The vein on which the mine was worked lay about a half-mile inland, and the shaft is being sunk at a depression between two hills at an elevation of about 150 feet above the lake. The vein where the shaft begins is about four feet wide and can be followed for about a quarter of a mile. The ore was brought up in buckets and dumped into a car. By January 1896 the main shaft had reached a depth of between 130-140 feet. Drifts were driven at the 60-foot 120-foot levels. The ore was processed with a ten-stamp mill.²⁸

In 1896 the manager was F. S. Wiley, and George Willoughby was the mine engineer. At the shaft, there was a 22-horsepower hoist and, a 25-horsepower boiler. The shaft was drained by two steam pumps, although at the time of the mining inspector's visit, the small amount of water entering the shaft was raised in buckets.²⁹

Fourteen men were then employed, six miners and three Indians, to haul supplies from Bonheur. The cooking and sleeping camps, an office, storehouse and stable, "all of an inexpensive character" where located on the lake shore.³⁰

About 200 feet south of No. 1 shaft is a second vertical shaft, which is connected to the lateral workings from No. 1 shaft on the 50-foot level. On the 240-foot level, north of No. 1 shaft, a winze was sunk to a further depth of 50 feet. Stopping was carried on north and south of No. 1 shaft on the 50- and 100-foot levels.³¹

²⁶ Ontario Dept. of Mines, *Annual Report* 1921 Part 2, "Ontario Gold Deposits Their Character, Distribution and Productiveness" by Percy E. Hopkins.

²⁷ Ont MNR *Geology of the Finlayson Lake Area* Fenwick 1976

²⁸ Bureau of Mines, *Annual Report*, 1896."Third Report on The West Ontario Gold Region

²⁹ Ibid.

³⁰ Ibid

³¹ Dept. of Mines *Annual Report*, 1939, Part 1,1939.



HERITAGE IMPACT ASSESSMENT HAMMOND REEF GOLD PROJECT



Source: Atikokan Museum.

Figure 5: Advertisement for the Hammond Property.

The mine was closed from March until August, 1898. Then on September 20, while drilling at the bottom of the shaft (230 feet deep) a considerable flow of water was struck that continued for months, flooding the lower part of the shaft and preventing further development. A drift was driven along the vein at the 220-foot level, and a winze sunk so that additional pumps could finally drain the water and shaft sinking continued.³²

While the underground work was closed, the company continued to extract ore from open pits. At 800 feet north of the shaft, an 80-foot crosscut was blasted out, a 20 foot sunk, and 1,000 tons of ore removed. Several hundred feet south of the main shaft three test-pits – 20, 8 and 4 feet – were sunk on outcroppings of what appears to be an extension of the Hammond Reef.³³

By October 1900, mining had stopped again. The option under which the mine was being worked by a syndicate had expired and all the men were discharged.³⁴

³² Bureau of Mines *Annual Report* 1900; Dept. of Mines Report 1925 "Gold Deposits of Kenora and Rainy River Districts," by E. L. Bruce.

³³ Bureau of Mines *Annual Report* 1900

³⁴ *Ibid.* 1899, Part One, 1900.



HERITAGE IMPACT ASSESSMENT HAMMOND REEF GOLD PROJECT



Figure 6: Sawbill 1896 (Ontario Bureau of Mines Report)

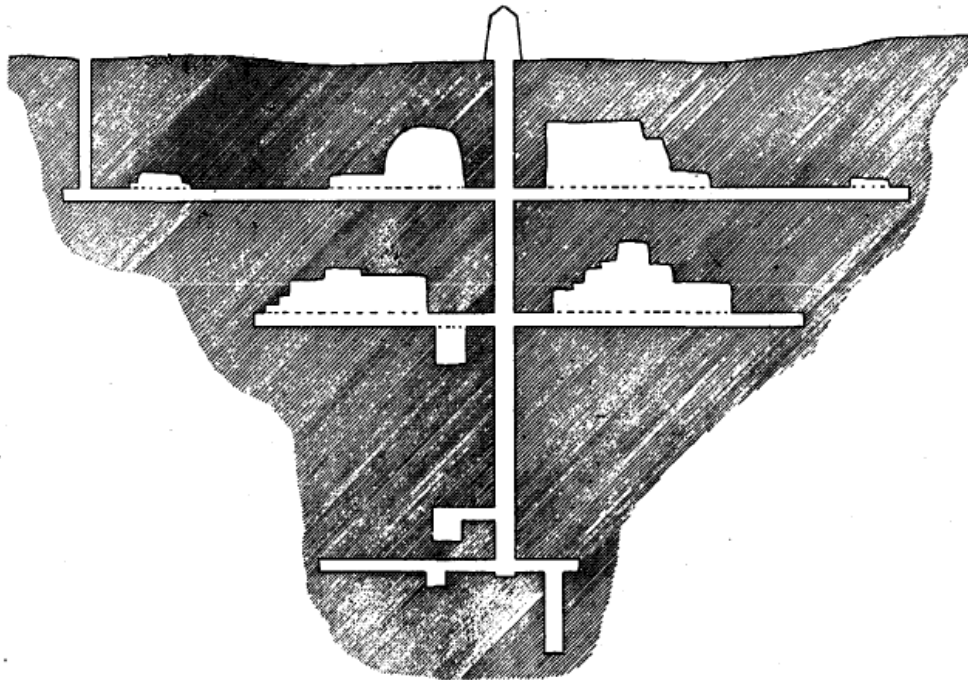

Figure 7: Ontario Department of Mines Annual Report 1921, Part 2 (Ontario Gold Deposits Their Character, Distribution and Productiveness by Percy E. Hopkins) This vertical section of the mine was originally published in the 1900 Annual Report.



HERITAGE IMPACT ASSESSMENT HAMMOND REEF GOLD PROJECT

Mining did not resume until the 1930s. The Upper Seine Gold Syndicate was created in 1936 and incorporated the following year as the Upper Seine Gold Mines, Limited. The head office was in Toronto and the mine address was Atikokan. W. N. McClintock was the mine superintendent, employing an average of 13 men. The property consists of 11 claims on 560 acres.³⁵ In 1936-1937 the company carried on surface exploration work and did some diamond-drilling. During the first six months of 1938 about 320 feet of drifting was done on the third level, and 500 feet of surface-trenching, was undertaken. Mining operations were suspended in June. A 50-ton amalgamation mill, formerly in use at the property of Hudson-Patricia Gold Mines Limited, was purchased and installed in 1939. Other equipment included a Blake jaw crusher, a ball mill, a Denver jig, and a Dorr rake classifier, corduroy blankets, and amalgam plates. The following buildings were erected: mill, blacksmith shop, magazine, caphouse, cook-house, ice-house, office, and an addition to the boiler-house. Dewatering of the mine began in 1937 but was not completed until 1941. Underground mining resumed for a few months but ended in September.³⁶



Source: Ontario Department of Mines.

Figure 8: No. 2 shaft, Elizabeth Mine, in 1937. It is assumed that the Sawbill Mine property would be of a similar character.

Upper Seine Gold Mines also acquired control of the Elizabeth Mine, closer to Atikokan. Gold was discovered on Claim F.M. 171 in 1900, by the Anglo-Canadian Gold Estates, Limited, of London, England. In 1902, a 10-stamp mill was constructed and by the end of 1903 two shafts, 500 feet apart, had been sunk. The mine closed in 1914. In 1936, the Elizabeth Gold Mining Company was incorporated by the same owners as the Upper Seine Gold Mines. The mine was worked for a time in 1938. The history of the property was undetermined after this date except that the property was later owned by J.P. Manley.³⁷

³⁵ Dept. of Mines, 1939, Part 1, 1939

³⁶ Ibid., 1937, Part 1 Mines in Ontario p.222-3; *Annual Report* 1939; Part 1; *Annual Report* 1941, p.140,

³⁷ Dept. of Mines, *Geology and Ore Deposits of the Atikokan Area*, 1939; Ont. MNR *Geology of the Finlayson Lake Area* Fenwick, 1976.



HERITAGE IMPACT ASSESSMENT HAMMOND REEF GOLD PROJECT

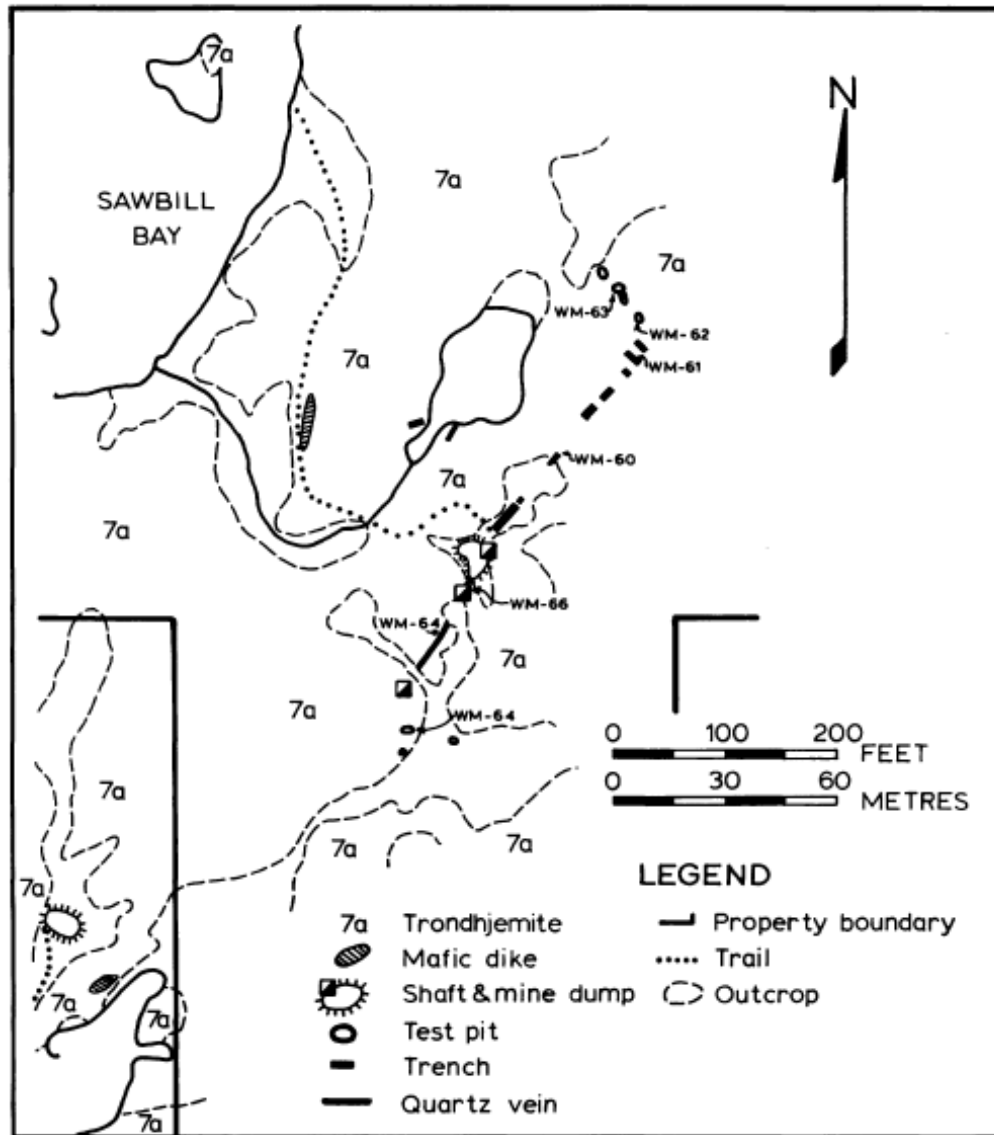

Figure 9: Geology of the Sawbill Mine. Ontario Ministry of Natural Resources. Ontario Geological Survey. Mineral Deposits Circular 24, Gold Deposits of the Atikokan Area by S.J. Wilkinson, 1982



HERITAGE IMPACT ASSESSMENT HAMMOND REEF GOLD PROJECT

3.3 Hammond Reef Property

The Hammond Reef mine was situated on the east shore of the upper part of Sawbill Bay in Marmion Reservoir, and three quarters of a mile southwest of the former Sawbill (Upper Seine Gold Mine). The term “reef” was apparently a local usage and derived from the presence of the shear zone that delineated the ore outcropping.³⁸

James Hammond discovered a broad band of gold bearing rock in 1896. The find was described as “*probably low grade but very extensive.*” The property of the Hammond Reef originally consisted of nine locations divided between two companies. The Folger-Hammond Gold Reef Mines Company had seven claims (316X to 322X) while the Hammond Gold Reef Mining Company Limited held two properties (337X and 338X). Both companies were controlled by the same investors. The owners soon realized that considerable capital expenditure was necessary to install a large mill and construct a hydroelectric power plant. Consequently, the two companies amalgamated as the Hammond Reef Consolidated Mining Company Limited.³⁹

A 10-stamp mill was installed on Claim 338X in 1897, and an additional thirty stamps were added in 1899. The mill was 35 by 100 feet, and 63 feet high. Ore was obtained from both an open-cut south with a depth of 35 feet and underground from a 60-foot shaft. A crusher house with a Blake crusher of 200 tons/day capacity was constructed close to the pit, about 800 feet from the mill. In 1898, all work confined to open pits, the underground work being abandoned. The ore was hauled by a tramway to the mill. There is a reference that this was an aerial tramway, rather than a tracked tramway, but it does not appear to have been completed. Initially the company built a dam above the mill to create a pond to provide water for the boilers for the steam drills, pumps, and other equipment. However, the water proved unsuitable and the pond was abandoned, and water was instead pumped from Sawbill Lake. The Ontario mine inspector recommended that the dam be breached to protect the mill in the event of heavy floods.⁴⁰

A hydroelectric plant using the discharge from Finlayson (Clearwater) Lake began operating in August, 1900. It was connected to the mill by a powerline just over two miles-long and crossed Sawbill Lake at the narrowest point and utilized several islands. On October 6, the mill motor was burnt out during a thunderstorm. As the mining results were discouraging, all work was discontinued when the motor was destroyed. Much of the machinery was hauled out to the railway at Hematite.⁴¹

No further mining occurred on the property. In 1928, the property was renamed the Rossmore Mine and owned by Copper Zinc Mines of Sudbury Limited. By c.1961, the property was acquired by Ventures Claims Limited, Toronto and, in turn, by Falconbridge in 1962.⁴²

³⁸ Ont. MNR *Geology of the Finlayson Lake Area* Fenwick, 1976.

³⁹ Bureau of Mines, *Annual Report*, 1896. “Third Report on the West Ontario Gold Region,” *Annual Report* 1900.

⁴⁰ Ibid. *Annual Report* 1899, Part One; Report 1900; Canada GSC *Geology Of The Area Covered By The Seine River; Map Sheets.*

⁴¹ Hematite was a station on the Canadian Northern Railway. Bureau Of Mines *Annual Report* 1900; Dept of Mines *Annual Report* 1925, “Gold Deposits of Kenora and Rainy River Districts,” by E. L. Bruce; *Annual Report* 1921 Part 2, “Ontario Gold Deposits Their Character, Distribution and Productiveness” By Percy E. Hopkins.

⁴² Ont MNR *Geology of the Finlayson Lake Area* Fenwick, 1976.



HERITAGE IMPACT ASSESSMENT HAMMOND REEF GOLD PROJECT



Source: Atikokan Museum.

Figure 10: Hammond Reef Mine - Mill House - What Appears to be Aerial Tramway on Roof.



HERITAGE IMPACT ASSESSMENT HAMMOND REEF GOLD PROJECT

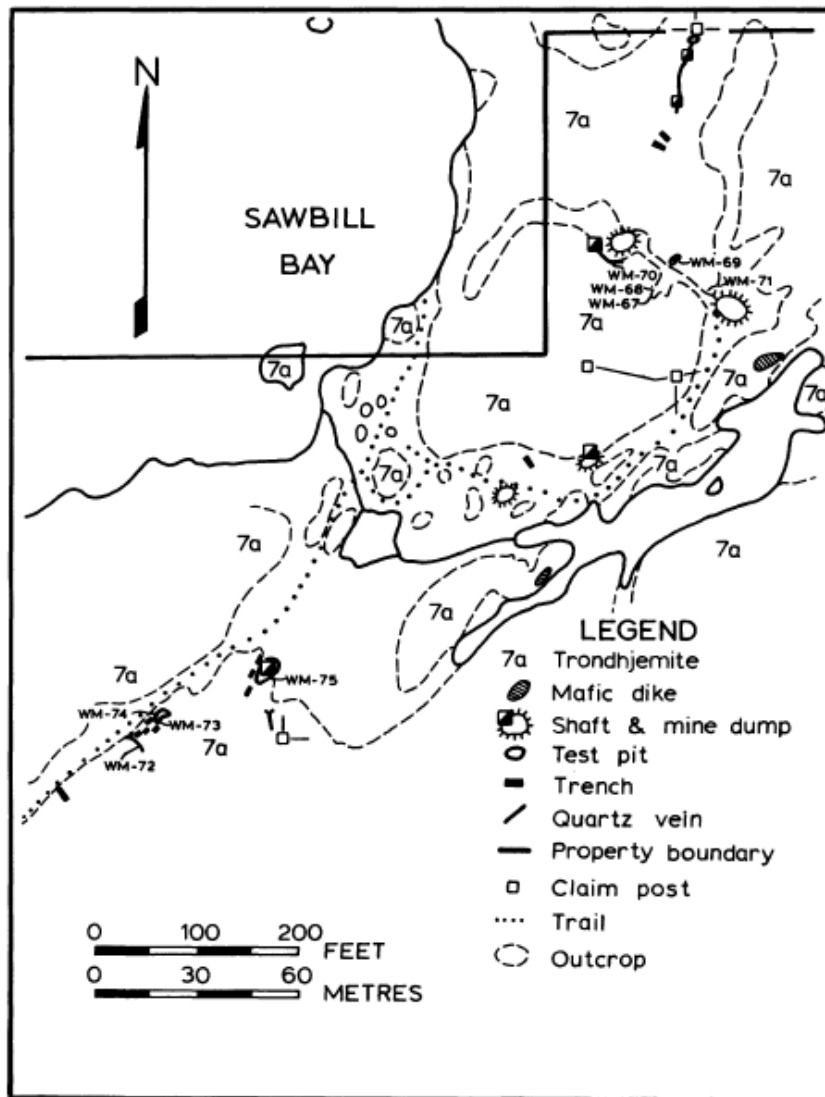

Figure 11: Geology of the Hammond Reef Mine. Ontario Ministry of Natural Resources. Ontario Geological Survey. Mineral Deposits Circular 24, Gold Deposits of the Atkokan Area by S.J. Wilkinson, 1982



HERITAGE IMPACT ASSESSMENT HAMMOND REEF GOLD PROJECT

4.0 SUMMARY

The gold discoveries in the Upper Seine Mining Region occurred as a result of the completion of the CPR in the 1880s. As a result:

*Intense excitement prevailed, and development was carried rapidly forward, although much of it, as in all such cases, was unjustified. The field produced, however, more than \$2,000,000 in gold, mainly between 1897 and 1903, although several properties have been operated intermittently since that time.*⁴³

The Sawbill and Hammond Reef mines were developed during this time. The reopening of the Sawbill Mine in the 1930s was the result of the Depression. Whereas other commodity prices fluctuated due to market factors, the price of gold was fixed at \$20.67 an ounce. The United States raised its guaranteed price to \$35 in 1934.⁴⁴ Not surprisingly new mines were started and old ones reopened – the Upper Seine Gold Mines Limited was organized in 1937 and began reworking the Elizabeth Mine in 1938 and the Sawbill in 1941.

The Hammond Reef Mine was unusual in that a considerable investment was made in a hydroelectric plant and a mill but little was done in developing the ore deposit itself. Almost all of the company's work concentrated on surface development with negligible underground work.

The creation of Marmion Reservoir in the 1920s may have flooded out any mine related development along the shoreline. The amount of mining infrastructure along the shoreline and the actual rise in water level at the mine site was not determined in this report.

The evolution of the Sawbill Mine represents a typical example of the small scale the c1890s and 1930s gold-mining eras in northwestern Ontario. The Hammond Mine seems to represent a more speculative approach to early mining with its significant investment in infrastructure.

5.0 STUDY AREA INVENTORY

5.1 Sawbill Mine

5.1.1 Mine Shafts

Three water filled shafts were identified during the fieldwork which matches the locations indicated on the geological map in Figure 9. The shaft entrances were all fenced using temporary snow fencing as a health and safety measure for the new mine operation (Figure 12). The main mine shaft contained a number of wooden beams which may date to the original mine operations (Figure 13).

⁴³ Canada. Dept. of Mines and Resources. *Geological and Economic Minerals of Canada (3rd ed) Economic Geology Series*, 1947.

⁴⁴ Philip Smith, *Harvest from the Rock; A history of Mining in Ontario*. Toronto. Macmillan, 1986



HERITAGE IMPACT ASSESSMENT HAMMOND REEF GOLD PROJECT



Figure 12: Main Shaft and Air Shaft from First Operation of the Mine (View Northeast)



HERITAGE IMPACT ASSESSMENT HAMMOND REEF GOLD PROJECT



Figure 13: Main Shaft of Sawbill Mine (View North)

5.1.2 Stamp Mill Foundation

A concrete foundation approximately 20m by 30m with a 5m by 15m addition on the west side of the structure was located 20m to the east of the main mine shaft (Figures 14-15). The structure contains four concrete platforms stepped one below the other on the downslope from the main shaft. Several concrete pedestals and low walls with rebar projecting from the top were scattered throughout the structure (Figures 16-17). The concrete pedestals indicate that the building housed large mechanical equipment which required significant structural reinforcement to operate. One large rectangular pit was located in the northeast portion of the structure (Figure 18).

The stepped design of the foundation indicates that the building was the mine's stamp mill. Both phases of operation at the mine had stamp mills operating on site during their activities. The structure as seen probably dates to the second phase of the mine operation. However, the favourable location for a gravity fed structure, as well as the position of the tramway, indicates that the original stamp mill could have been located here as well or the foundation could have been refurbished from the original operation for the second mine phase.



HERITAGE IMPACT ASSESSMENT HAMMOND REEF GOLD PROJECT



Figure 14: Northwest Corner of the Stamp Mill Foundation Looking along the South Wall of the Structure (View West)



Figure 15: View of the Interior of the Structure from the Northwest Corner of the Stamp Mill Foundation (View South)



HERITAGE IMPACT ASSESSMENT HAMMOND REEF GOLD PROJECT



Figure 16: View of Southeast Corner of the Stamp Mill (View West)



Figure 17: View of Concrete Pedestals in the Central Area of the Stamp Mill (View West)



HERITAGE IMPACT ASSESSMENT HAMMOND REEF GOLD PROJECT



Figure 18: Concrete Tank to Right of the Concrete Slab in Northeast Portion of Stamp Mill Foundation (View East)

5.1.3 Engine

A large two-cylinder gasoline (or diesel) engine was located approximately 10m east of the main shaft (Figure 19). The engine was still located on its original concrete bed. The engine appears to be in relatively good condition and most of its components are still in place (Figures 20-21). A builder's plate identified it as "Imperial Keighley." This company manufactured oil and gas engines in the early 20th century in Keighley, England. The placement of the engine adjacent to the main shaft indicates that it was likely the hoist engine. When in operation, the engine would have been enclosed in a hoist house. No evidence of the structure remained at the time of the site visit. The engine is assumed to have been installed in the 1930s.



HERITAGE IMPACT ASSESSMENT HAMMOND REEF GOLD PROJECT



Figure 19: Engine Orientated North-South (View Northwest)



Figure 20: South End of the Engine with Imperial Keighley Marking Visible (View North)



HERITAGE IMPACT ASSESSMENT HAMMOND REEF GOLD PROJECT



Figure 21: Flywheel of Engine on West Side of the Engine (View Northwest)

5.1.4 Tramway

A tramway originally connected the stamp mill with Sawbill Bay. The approximate location of the tramway is labelled as a trail on the geological map of the mine (Figure 9). The extant remains of the tramway consist of a thick rubble platform over the majority of the path of the tramway (Figure 22-25). Closer to Sawbill bay the base of the platform thins considerably until it is mostly visible as a pair of parallel ditches (Figure 26). The width of the tramway stays consistent at approximately 2 m along the entire length.

A concrete pad, approximately 20 x 30 m, was located on the west side of the tramway approximately 20 m north of the creek crossing seen on the geological map (Figure 9). This platform contained no distinctive features. However, considering it was located approximately 3 m lower in elevation than the platform of the tramway, it is probable that the pad served as support for a wooden structure which was level with the tramway platform.



HERITAGE IMPACT ASSESSMENT HAMMOND REEF GOLD PROJECT



Figure 22: View on Top of the Tramway near the Stamp Mill (View Northwest)



Figure 23: Close-up of the Base of the Tramway (View South)



HERITAGE IMPACT ASSESSMENT HAMMOND REEF GOLD PROJECT



Figure 24: Tramway Abutment for Crossing of a Creek (View Southeast)



Figure 25: View of the Side of the Tramway from Concrete Slab West of the Tramway (View North)



HERITAGE IMPACT ASSESSMENT HAMMOND REEF GOLD PROJECT



Figure 26: Tramway with Thin Base Mostly Seen as a Ditch in the Centre of the Photograph (View Northwest)

5.1.5 Prospecting Trenches and Ore Pits

The geological map of the area, seen in Figure 9, identifies numerous trenches which were observed in the field work. The greatest concentration was observed along the crest of the hill (Figures 27-28). The trenches are now primarily overgrown.



HERITAGE IMPACT ASSESSMENT HAMMOND REEF GOLD PROJECT



Figure 27: Surface Trench along the William Vein (View Northeast)



Figure 28: Surface Trench near Sawbill mine (View Southwest)



HERITAGE IMPACT ASSESSMENT HAMMOND REEF GOLD PROJECT

5.2 Hammond Reef Mine

5.2.1 Adit

Two adits were noted during the field visit (Figure 29). These mine entrances had no visible historic infrastructure in place around them. One adit had several pieces of machinery nearby which was part of a large engine (Figure 30). The areas around the entrances were particularly disturbed having the main road for the new mine infrastructure running directly in front of both.



Figure 29: Adit for the Original Hammond Reef Mine (View North)



HERITAGE IMPACT ASSESSMENT HAMMOND REEF GOLD PROJECT



Figure 30: Drive Wheel for Engine Found in Front of Hammond Reef Adit (View Northwest)

5.2.2 Dam

At the base of the south side of the hill on which the Sawbill mine sits, runs a stream valley visible in the geological map of the Sawbill mine as a gap between the Trondhjemite gneiss bedrock (Figure 9). This drainage continues southwest for approximately a kilometre before turning north to drain into Sawbill bay. Along the stream valley, three dams were noted, two timber cribs dams and one earthen dam constructed of waste rock. A pair of these dams were located approximately 200 m to the south Sawbill mine and could have created a large pond from their construction (Figures 31-33). This valley had two channels, one which was blocked by an earthen dam which would have redirected most or all of the water into the smaller eastern channel (Figures 34-35).



HERITAGE IMPACT ASSESSMENT HAMMOND REEF GOLD PROJECT



Figure 31: Timber Crib Dam Structure along Secondary Channel in Stream Valley (View West)



HERITAGE IMPACT ASSESSMENT HAMMOND REEF GOLD PROJECT



Figure 32: Close up of Timber Crib Dam Structure (View North)



HERITAGE IMPACT ASSESSMENT HAMMOND REEF GOLD PROJECT



Figure 33: Former Head Pond above the Timber Crib and Waste Rock Dams; now Silted In. (View East)



Figure 34: Two Channels from Head Pond, Smaller Channel with Timber Dam to the Right (View East)



HERITAGE IMPACT ASSESSMENT HAMMOND REEF GOLD PROJECT



Figure 35: Waste Rock Dam Blocking Main Channel of the Head Pond (View southeast)

5.2.3 Trenches and Pits

The only area of open cut which was identified was found along the edge of a rock hill and was fenced off due to a shaft located in the area (Figure 36). This trench area is labelled with the sample number WM-70 on the geology map of the mine (Figure 11).



HERITAGE IMPACT ASSESSMENT HAMMOND REEF GOLD PROJECT



Figure 36: Large Open Pit Associated with the Original Hammond Reef Mine (View Northeast)

5.3 Other Sites

Several small cabin structures, in various states of repair, were identified along the shores of Marmion Reservoir during the Stage 2 archaeological assessment. Most of the structures appeared to have been abandoned. No photos were taken of these structures during the assessment. All of the structures appeared to date to the mid-20th century. These sites will not be impacted by the proposed mine development as they are located along the Marmion Reservoir shoreline outside the footprint of the proposed mine operation.

5.4 Cultural Heritage Landscapes

No cultural heritage landscapes were identified during the Stage 2 archaeological assessment. The frame structures have rotted away in the 70 years since mining activity ceased and concrete ruins, relic equipment and mine shafts/pits have been obscured by natural regeneration of vegetation. Property exploration activities associated with the new development have created a modern, exploration landscape. Collectively, these activities/conditions today do not convey a sense of an early 20th century mining landscape.



HERITAGE IMPACT ASSESSMENT HAMMOND REEF GOLD PROJECT

6.0 CULTURAL HERITAGE VALUE

6.1 Method of Evaluation

Properties of cultural heritage value located in unorganized territories can be designated by the Minister of Tourism Culture and Sport under the provisions of *Ontario Heritage Act* Section 35.5 if they meet the criteria prescribed in O. Reg. 10/06. As the Project is located, in part, on crown land in the District of Rainy River, the cultural value of the former Hammond Reef Mine and the Sawbill Mine would be determined by O. Reg. 10/06.⁴⁵ The typical process to determine cultural heritage value is to first assess the property according to O.Reg 9/06 and then, if it has value, to apply O.Reg 10/06 criteria.

6.1.1 Regulation 9/06 Evaluation

The following are the O.Reg 9/06 criteria for determining if a property has cultural heritage value or interest:

- 1) The property has design value or physical value because it,
 - i) is a rare, unique, representative or early example of a style, type, expression, material or construction method,
 - i) displays a high degree of craftsmanship or artistic merit, or
 - vi) demonstrates a high degree of technical or scientific achievement.
- 4) The property has historical value or associative value because it,
 - i) has direct associations with a theme, event, belief, person, activity, organization or institution that is significant to a community,
 - ii) yields, or has the potential to yield, information that contributes to an understanding of a community or culture, or
 - iii) demonstrates or reflects the work or ideas of an architect, artist, builder, designer or theorist who is significant to a community.
- 5) The property has contextual value because it,
 - i) is important in defining, maintaining or supporting the character of an area,
 - ii) is physically, functionally, visually or historically linked to its surroundings, or
 - iii) is a landmark.

The Hammond and Sawbill Mines were determined by O.Reg 9/06 Criterion (2 - i) to be properties of *Historical Value* or *Associative Value* because both mine sites fit into the pattern of development for the first mining ventures in northwestern Ontario. In addition the Sawbill Mine was part of the second gold mining era in Ontario in the 1930s.

⁴⁵ The ownership of the properties of the Sawbill and Hammond Mines were not identified.



HERITAGE IMPACT ASSESSMENT HAMMOND REEF GOLD PROJECT

6.1.2 Regulation 10/06 Evaluation

The following are the O.Reg 10/06 criteria for determining if a property has cultural heritage value or interest:

- 1) The property represents or demonstrates a theme or pattern in Ontario's history.
- 2) The property yields, or has the potential to yield, information that contributes to an understanding of Ontario's history.
- 3) The property demonstrates an uncommon, rare or unique aspect of Ontario's cultural heritage.
- 4) The property is of aesthetic, visual or contextual importance to the province.
- 5) The property demonstrates a high degree of excellence or creative, technical or scientific achievement at a provincial level in a given period.
- 6) The property has a strong or special association with the entire province or with a community that is found in more than one part of the province. The association exists for historic, social, or cultural reasons or because of traditional use.
- 7) The property has a strong or special association with the life or work of a person, group or organization of importance to the province or with an event of importance to the province.

The Hammond and Sawbill Mines were determined by O.Reg 10/06 Criterion (1) to be properties that represent or demonstrate a theme or pattern in Ontario's history for the same reason as the 9/06 evaluation:

Both mine sites fit into the pattern of development for the first mining ventures in northwestern Ontario. In addition the Sawbill Mine was part of the second gold mining era in Ontario in the 1930s.

6.2 Statement of Cultural Heritage Value

The evolution of the Sawbill Mine represents a typical example of the small scale the c.1890s and 1930s gold-mining eras in northwestern Ontario. The surface remnants of the shafts, pits and trenches, the ruins of the mill building and engine, and the evidence of former tramway trace the location of the mining operation; primarily of the 1930s era.

The Hammond Mine represents an example of the mining activity of the c. 1890s during the first gold-mining era in northwestern Ontario. The mine adit does not seem to have been required at other local mining properties and therefore appears to be a relatively uncommon mine landscape features. The remnant of the dams and reservoir appear to represent the greater investment in mine infrastructure than was typical in other local mining ventures.

These two properties are indicators of early mining practice in northwestern Ontario and the process of the economic development of the area. Their cultural heritage value is of local, and not provincial, importance.

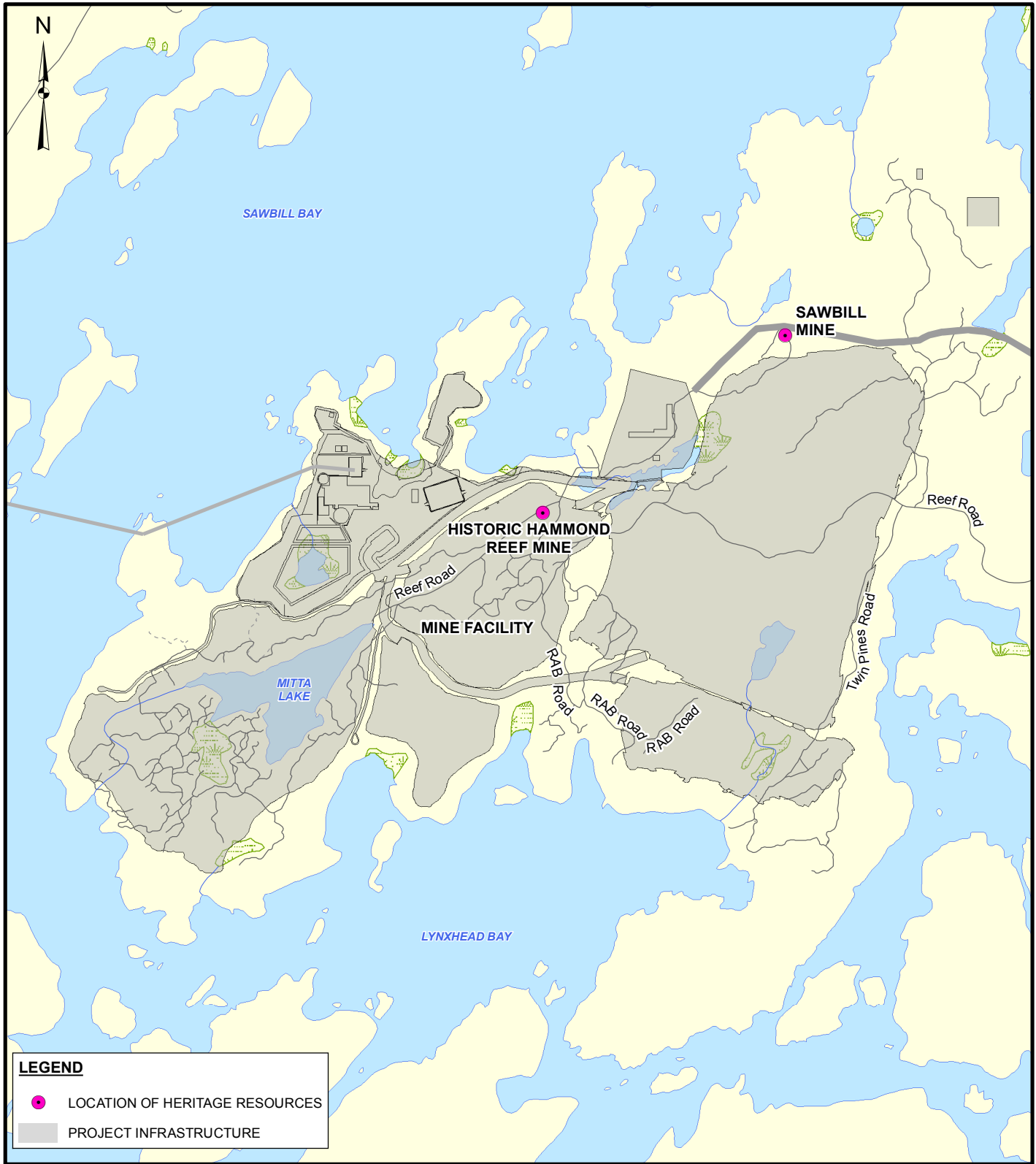

LEGEND

- LOCATION OF HERITAGE RESOURCES
- PROJECT INFRASTRUCTURE

REFERENCE

BASE DATA - PROVIDED BY OSISKO HAMMOND REEF GOLD PROJECT LTD.;
 BASE DATA - MNR NRVIS, OBTAINED 2004. PRODUCED BY GOLDER ASSOCIATES LTD
 UNDER LICENCE FROM ONTARIO MINISTRY OF NATURAL RESOURCES, © QUEENS PRINTER 2012
 PROJECTION: TRANSVERSE MERCATOR DATUM: NAD 83 COORDINATE SYSTEM: UTM ZONE 15N

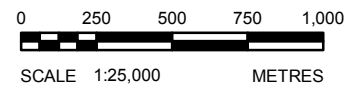

DATE	2014-05-28
DESIGN	CP
GIS	BR

LOCATION OF HERITAGE RESOURCES

PROJECT No. 13-1118-0010-5006

SCALE AS SHOWN

VERSION 2

CHECK
REVIEW

PROJECT HAMMOND REEF GOLD PROJECT
 ATIKOKAN, ONTARIO, CANADA

MAP 3



HERITAGE IMPACT ASSESSMENT HAMMOND REEF GOLD PROJECT

7.0 POTENTIAL IMPACTS AND MITIGATION

7.1 Proposed Undertaking

The Project is a planned open pit mine with associated ancillary facilities. Prior to the commencement of mining, a mine hazard audit will be undertaken to identify potential hazards on the property prior to the commencement of mining.

The historic Sawbill and Hammond Mine Sites are located in areas that will be part of the active mining operation. The Sawbill Mine is located immediately north of the proposed Waste Rock Stockpile and adjacent to the proposed access road right of way. The Hammond Mine site is located within the boundaries of the proposed East Pit of the Mine operation.

7.2 Potential Impacts

Two phases of the mining operation may impact the cultural resources of the Sawbill and Hammond Mines.

First, the mine hazard audit may identify hazards, such as adits and pits associated with the historic Sawbill and Hammond Mine sites. The hazards posed by the historic mining activities may have to be mitigated prior to the commencement of mining activities.

Second, historic mine related features are located within the Project development area. The Sawbill Mine site is located within a confined area between the planned mine access road and utility corridor, and the waste rock stockpile. During the development of the Project, the design of the road and waste rock stockpile may require modification that could require the removal of historic features associated with the Sawbill Mine. The historic Hammond Mine site is located within the planned East Pit mining area and the mine site will be removed.

7.3 Potential Mitigation

7.3.1 Documentation

Comprehensive photographic documentation of the Sawbill and Hammond historic mine sites could be undertaken prior to mine development of the Project. Documentation should be stored in a publically accessible location. Site documentation will fulfill three separate functions. It will provide:

- A permanent visual record of the historic mine sites prior to their removal as a result of the Project activities;
- A component of the protection plan mitigation strategy described in 7.3.2 below; and
- A component of the graphic/research material for use in the site interpretation plan described in 7.3.3 below.

Documentation of the resources has not yet occurred. The *Cultural Heritage Resources TSD* (December 2013) submitted by Canadian Malartic was an archaeological report that determined that the historic mines sites did not have archaeological significance. Additional research and reassessment of the 2012 archaeological filed work undertaken for this 2014 HIA determined that the two historic mine sites do have cultural heritage value.



HERITAGE IMPACT ASSESSMENT HAMMOND REEF GOLD PROJECT

7.3.2 Protection

The location of cultural resources for the historic Sawbill Mine site could be mapped, using data from 7.3.1 above, as an environmental consideration for the Project. The purpose of the protection plan is to identify the location of the historic physical resources so that their location can be considered as the design of the Project facilities is progressed. If possible, it is recommended that historic physical resources be left as monuments in the landscape after the Project has been completed.

The historic Hammond Mine site is located within the planned East Pit mining area and the historic features will be removed. No further site mitigation is required once the site is properly documented.

Future Project development should take into account the presence of the historic mine features and, if possible avoid these features. If this is not possible, the features could be removed because they have been documented as per Section 7.3.1 (above). However, “best-practice” for the protection of cultural heritage resources identifies that preservation of the resource is preferred to documentation followed by removal.

7.3.3 Interpretation Plan

The Canadian Malartic Community Consultation Committee could work with one, or more, local or regional cultural heritage institutions to interpret the history of gold mining in the region. An interpretation plan could provide both educational and tourism functions. Some mine related features at the historic Sawbill and Hammond Mines – such as a large, two-cylinder engine at the Sawbill Mine site (Figure 19) – could be relocated and preserved to interpret gold mining activities. Other artifacts may be identified during the documentation identified in Section 7.3.1 (above). Historic themes associated with 20th century mining in the region, particularly gold and iron mining, and hydrographic changes to the Seine River water system, are among the concepts that could be interpreted.

8.0 RECOMMENDATIONS

8.1 Documentation Programme

Prior to any further mine development in the vicinity of the two historic mine sites, the properties should be photographically documented and mapped to illustrate the:

- condition of the mine structures
- relationship of the structures to the surrounding setting/landscape;
- technical details of any features that exhibit distinctive design characteristics; and
- any additional features that were not identified during the archaeological survey.

This photo documentation should be undertaken under optimal environmental conditions (i.e. no snow cover, before/or after tree leafing, clear sky, appropriate sun/shadows, etc.) and accompanied with notes and sketch maps to assist in interpreting the photos. High quality digital photography should be undertaken by qualified individual(s).



HERITAGE IMPACT ASSESSMENT HAMMOND REEF GOLD PROJECT

Copies of this photo documentation, this 2014 HIA, and any further site research or documentation undertaken by Canadian Malartic should be deposited with the:

- Atikokan Public Library
- Lakehead University Library
- Other depositories to be determined.

8.2 Protection Plan

The location of cultural resources for the historic Sawbill Mine site should be plotted, using data obtained during the documentation programme, as an environmental consideration for the Project. The historic resource map should identify the location of the historic physical resources so that their location can be considered as the design of the Project facilities is progressing. If possible, it is recommended that historic physical resources be left as monuments in the landscape after the Project has been completed.

8.3 Interpretation Plan

An interpretation program should be developed as a partnership with identified local and regional institutions. In order to initiate this program, the Canadian Malartic Community Consultation Committee should define Canadian Malartic's commitment as follows:

- I. Identify community partners to work with to develop and manage an interpretation program
- II. Determine the company's financial commitment to an Interpretation Plan, specifically:
 - Relocation of artifacts - cost of moving; stabilization
 - Production of exhibit/interpretation materials
- III. Define the company's long term corporate involvement in the Interpretation Plan

9.0 FOLLOW-UP WORK COMPLETED

Since the initial draft of this HIA was prepared, the following work additional has been completed by Canadian Malartic based on the recommendations provided in Section 8.0:

- A photographic documentation programme was completed in October 2014 and is appended as *Appendix A*. This programme included mapping of the cultural resources and fulfills recommendations 8.1 and 8.2; and
- A mitigation plan was prepared and is appended as *Appendix B*. This plan includes options for the development of an interpretation plan for discussion with the Town of Atikokan which will ultimately fulfill recommendations 8.3.



HERITAGE IMPACT ASSESSMENT HAMMOND REEF GOLD PROJECT

10.0 SOURCES

10.1 Government Documents

Canada. Geological Survey of Canada. *Report on the Geology of The Area Covered by the Seine River and Lake Shebandowan Map-Sheets*. By William: McInnes, B.A. 1899

----- Dept of Mines and Resources. *Geological and Economic Minerals of Canada* (3rd ed) Economic Geology Series, 1947.

Ontario. Bureau of Mines/Dept. of Mines, *Annual Reports*, 1896-1939, various years

Annual Report special reports:

1896, Part 1, "Third Report on The West Ontario Gold Region," By A. P. Coleman.

1925, Part 6, "Gold Deposits of Kenora and Rainy River Districts," by E. L. Bruce 1-42

1939 Part 2, "Geology and Ore Deposits of the Atikokan Area, by E. S. Moore:

Ontario. Ministry of Tourism Culture and Sport *Heritage Resources in the Land Use Planning Process*. 2006.

Ontario. Ministry of Natural Resources, Division of Mines *Geology of the Finlayson Lake Area District of Rainy River*. K. G. Fenwick. Geoscience Report 145, 1976

----- Ministry of Natural Resources Ontario Geological Survey. *Mineral Deposits Circular 24*, Gold Deposits of the Atikokan Area by S.J. Wilkinson, 1982

United States. National Register of Historic Places. *Bulletin #42, Guidelines for Identifying, Evaluating and Registering Historic Mining Properties*.

10.2 Secondary Sources

Cranstone, Donald 2002. *A History of Mining and Mineral Exploration in Canada and Outlook for the Future*. Natural Resources Canada, Ottawa.

Smith, Philip. *Harvest from the Rock; A history of Mining in Ontario*. Toronto. Macmillan, 1986

10.3 Electronic Sources

Seine River Watershed Information - seineriverwmp.com/history.html

11.0 CLOSURE

We trust that this report meets your current needs. If you have any questions, or if we may be of further assistance, please contact the undersigned.



HERITAGE IMPACT ASSESSMENT HAMMOND REEF GOLD PROJECT

Report Signature Page

GOLDER ASSOCIATES LTD.

<Original signed by>

Stephen Jarrett, M.A.
Staff Archaeologist

<Original signed by>

Ken DeVos, P. Geo.
Principal, Project Director

SRJ/CAA/db/Slc/sp

<Original signed by>

Christopher Andrea, Ph.D.
Associate, Senior Built Heritage Specialist

Golder, Golder Associates and the GA globe design are trademarks of Golder Associates Corporation.

\\golder.gds\gal\mississauga\active\2014\1188\1408383-cm -hammond reef ea follow-up\3100 - cultural heritage\doc005_heritage impact assessment\1408383_doc005 rev 1_final
hia_07apr2015.docx



**HERITAGE IMPACT ASSESSMENT
HAMMOND REEF GOLD PROJECT**

APPENDIX A

Hammond Reef Heritage Photographic Documentation



April 2015

HAMMOND REEF GOLD PROJECT

Hammond Reef Heritage Photographic Documentation

Submitted to:
Cathryn Moffett
Canadian Malartic Corporation
145 King Street East, Toronto, ON

REPORT



Report Number: 1408383
Document Number: 003 (Rev 0)





HAMMOND REEF HERITAGE PHOTOGRAPHIC DOCUMENTATION

Table of Contents

1.0 INTRODUCTION.....	1
2.0 HAMMOND REEF MINE.....	5
2.1 Mine Adits.....	7
2.2 Rock Cut.....	12
2.3 Log Cabin.....	16
2.4 Mill Location.....	20
2.5 Hammond Reef Timber Dam.....	28
3.0 SAWBILL MINE.....	31
3.1 Mine Shafts.....	34
3.2 Mill Building Foundations.....	41
3.3 Keighley Engine.....	45
MAPS	
Map 1: Site Plan for Hammond Reef and Sawbill Mines.....	4
Map 2: Photo Locations of Historic Features – Hammond Reef Mine.....	30
Map 3: Photo Location of Historic Features – Sawbill Mine.....	58
FIGURES	
Figure 1: Tramway roadbed on an earth embankment in valley near the Sawbill Mine, October 2011. Source Golder Stage 1 Baseline Study and Stage 2 Archaeological Assessment 2013.....	2
Figure 2: Stone dam remains of former power plant. October 2011. Source Golder Stage 1 Baseline Study and Stage 2 Archaeological Assessment 2013.....	3
Figure 3: Geology of the Hammond Reef Mine showing location of rock cut (Section 2.2) and the timber dam (Section 2.5). (Ontario Ministry of Natural Resources. Geological Survey. Mineral Deposits Circular 24, Gold Deposits of the Atikokan Area, 1982).....	6
Figure 4: HAZELWOOD wood stove from 1892 Gurney Catalogue, Hamilton Ontario.....	16
Figure 5: Hammond Reef Mine - Mill House - What Appears to be Aerial Tramway on Roof. (Source: Atikokan Museum).....	20
Figure 6: Cross Section of mill building using gravity feed. (Source: International Textbook Company, A Textbook on Metal Mining 1899).....	21
Figure 7: Typical stamp mill (left) with two sets of five stamps (Source: International Textbook Company, A Textbook on Metal Mining 1899).....	22
Figure 8: Mining, Stamp Mill (right), originally from the Golden Winner Gold Mine and relocated to park. Atitokan Historical Park Oct 23, 2014.....	22



HAMMOND REEF HERITAGE PHOTOGRAPHIC DOCUMENTATION

Figure 9: Mining, Stamp Mill, Atikokan Historical Park, Oct 23, 2014.....	23
Figure 10: Stamp Mill Box (Source: International Textbook Company, A Textbook on Metal Mining 1899).....	23
Figure 11: Close Up of Timber Crib Dam Structure, October 2011 (Source Golder Stage 1 Baseline Study and Stage 2 Archaeological Assessment 2013.	28
Figure 12: Sketch of timber dam (Source: James Leffel Construction of Mill Dams 1881, Reprint Noyes Press, 1972)	28
Figure 13: No. 2 shaft, Elizabeth Mine, in 1937. The mine was controlled by the same owners as the Sawbill Mine. It is assumed that the Sawbill Mine property would be of a similar character. (Source: Ontario Dept. of Mines, Geology and Ore Deposits of the Atikokan Area, 1939.).....	32
Figure 14: Geology of the Sawbill Mine. (Source: Ontario Ministry of Natural Resources. Ontario Geological Survey. Mineral Deposits Circular 24, Gold Deposits of the Atikokan Area, 1982).....	33
Figure 15: Sawbill mine c 1900. (Ontario Department of Mines Annual Report 1921, Part 2 Ontario Gold Deposits Their Character, Distribution and Productiveness; mine section was originally published in 1900 Annual Report)	34
Figure 16: Plan of mine shaft framing for a pump way and two cage ways. (Source: International Textbook Company, A Textbook on Metal Mining 1899).....	35
Figure 17: Isometric view of shaft timber framing. (Source: International Textbook Company, A Textbook on Metal Mining 1899).....	35
Figure 18: Keighley Gas & Oil Engine Catalogue - no date cover. Illustrates a single cylinder model but otherwise similar in design. (Source: Rural History Centre, The University of Reading UK [www.rhc.rdg.ac.uk])	46

PLATES

Plate H-1: Adit 1, Entrance.....	8
Plate H-2: Adit 1 looking from entrance with end of tunnel in rear.....	9
Plate H-3: Adit 2, Entrance.....	10
Plate H-4: Adit 2 looking from entrance; the end of tunnel in not visible	11
Plate H-5: Overview of Rock Cut with pond in foreground	13
Plate H-6: Looking Over Quarry Face with Drill Hole	14
Plate H-7: Looking Over Quarry Face with Iron Ring	15
Plate H-8: Mine cabin, corner joints	17
Plate H-9: Mine cabin, stove parts	18
Plate H-10: Mine cabin, side casting of wood stove	19
Plate H-11: Overview of mill site showing modern grading	24
Plate H-12: Stamp mill box.....	25
Plate H-13: Two pulleys on axle with the equipment dump.....	26
Plate H-14: Concrete machinery base with notebook for scale	27
Plate H-15: Overview of dam showing timber framing on upstream side	29
Plate S-1: Looking north from Shaft Three towards Shaft Two in middle and Shaft One in rear	36



HAMMOND REEF HERITAGE PHOTOGRAPHIC DOCUMENTATION

Plate S-2: Shaft One, looking west towards concrete ruins of mill building	37
Plate S-3: Shaft One showing water in shaft, mine timber (right) and tramway rails (left).....	38
Plate S-4: Shaft Two	39
Plate S-5: Shaft Three looking south and up slope to the shaft.....	40
Plate S-6: Mill foundation overview looking from Shaft One.....	42
Plate S-7: Concrete footings for pillow blocks, looking towards Shaft One	43
Plate S-8: Two concrete tanks on lowest level of mill foundation	44
Plate S-9: Keighley Engine, north side	47
Plate S-10: Keighley Engine, south side	48
Plate S-11: Keighley Engine, south side	49
Plate S-12: Keighley Engine, east side	50
Plate S-13: Keighley Engine, west side.....	51
Plate S-14: Keighley Engine, east side	52
Plate S-15: Keighley Engine, flywheel.....	53
Plate S-16: Keighley Engine, flywheel/belt drive	54
Plate S-17: Keighley Engine, east side; small steam engine.....	55
Plate S-18: Small steam engine west of Keighley Engine.....	56
Plate S-19: Pulley block west of Keighley Engine	57



HAMMOND REEF HERITAGE PHOTOGRAPHIC DOCUMENTATION

1.0 INTRODUCTION

In 2011 Golder Associates Ltd (Golder) completed an Archaeological Assessment of the proposed Hammond Reef Gold Project located approximately 170 km northwest of Thunder Bay, Ontario. In 2014 Golder undertook a Heritage Impact Assessment for the project as a component of the *Canadian Environmental Assessment Act* and the *Ontario Environmental Assessment Act* requirements. One recommendation of the Heritage Impact Assessment was that prior to any further mine development a program of documentation of historic mining features be undertaken. The property contained two historic mine sites known as the Hammond Reef Mine and the Sawbill Mine. This documentation would mitigate adverse impacts of the proposed gold mining venture.

On October 21 and 22, 2014, Christopher Andreae and Michael Greguol of Golder's Built Heritage Group photographed the physical remains of the Hammond and Sawbill Mines as identified in Map 1. They were accompanied by Cathryn Moffett and Bud Dickson of the Canadian Malartic Corporation (Canadian Malartic). The weather during the field documentation was warm, clear and sunny.

The documentation program consists of two components. This *Report* contains selected photographs from the field documentation with explanatory text. The location of each photograph is identified in Map 2 (Hammond Reef Mine) and Map 3 (Sawbill Mine). In addition to the field work findings, additional graphics and some of the archaeological photography have been included in this report to assist in interpreting the photographs. The photo documentation images are called *Plates* in this report; any other photography and additional graphics are referred to as *Figures*.

The second component of the documentation is a CD containing all of the photography undertaken on October 21 and 22. The *Report* and the CD photographs have been deposited with the Atikokan Museum.

By the time this documentation was undertaken, many of the historic features of the historic mine sites had been altered or demolished. These actions occurred over a long period of time. In 1921 the Ontario Bureau of Mines noted that "much of the machinery" from the Hammond Mine had been hauled out to the Canadian National Railway station at Hematite.¹ During the 20th century the mine sites were periodically reassessed for their mineral potential. The exploration work associated with each investigation resulted in the removal of portions of the historic mining landscape. The most intensive investigations were carried out by Falconbridge, in the 1980s, Pentland Firth Ventures in the 1990s, and Brett Resources in c.2006-2010.

Despite the exploration activity over time, a surprising amount of material culture remains for both historic mines both on, and off the property. Much of this material is of a landscape character rather than individual structures. At Sawbill, the mine shafts are still visible as is the relationship between the haulage shaft and the mill operation. At the Hammond Reef Mine, the open pit quarry and mine adits are distinctive mine features. Moreover, some c1900 mill equipment still survives and is partially buried in a dump. The "Imperial-Keighley" diesel engine at the Sawbill Mine is the only historic piece of equipment to survive, almost intact, and in its original location (See Section 3.3).

Transporting heavy mining equipment to the two isolated mines sites in the 1890s would have been a major undertaking. This was accomplished over the 50 km Bonheur Tail between Bonheur station on the Canadian

¹ Hematite was a station on the Canadian Northern Railway. Ont. Dept of Mines *Annual Report* 1925, "Gold Deposits of Kenora and Rainy River Districts;" *Annual Report* 1921 Part 2, Ontario Gold Deposits Their Character, Distribution and Productiveness".



HAMMOND REEF HERITAGE PHOTOGRAPHIC DOCUMENTATION

Pacific Railway and Sawbill Lake; a water route in the summer and sleigh road in winter. In 1902, the Canadian Northern Railway (today part of the Canadian National) completed a line through the Town of Atikokan and provided a somewhat shorter route.² Earthwork remnants in 2014 of the Bonheur Trail and connections to the mine sites are located outside of the mining property but were identified in the 2011 Golder archaeological assessment (Figure 1).



Figure 1: Tramway roadbed on an earth embankment in valley near the Sawbill Mine, October 2011. Source Golder Stage 1 Baseline Study and Stage 2 Archaeological Assessment 2013.

The Archaeological Report also identified remnants of the Hammond Reef Mine hydroelectric plant completed in August 1900 (Figure 2). The powerhouse was built where Finlayson (formerly Clearwater) Lake entered Sawbill Bay on the opposite shore to the mine. A three kilometre power line connected the plant to the mine, and on to the mill. In October the electric motor at the mine mill was burnt out during a thunderstorm. The motor was not repaired and the mine was closed.³

² Bureau Of Mines, *Annual Report*, 1896., 1900, 1939, Part 1,

³ Ontario. Bureau Of Mines *Annual Report* 1900.



HAMMOND REEF HERITAGE PHOTOGRAPHIC DOCUMENTATION



Figure 2: Stone dam remains of former power plant. October 2011. Source Golder Stage 1 Baseline Study and Stage 2 Archaeological Assessment 2013.

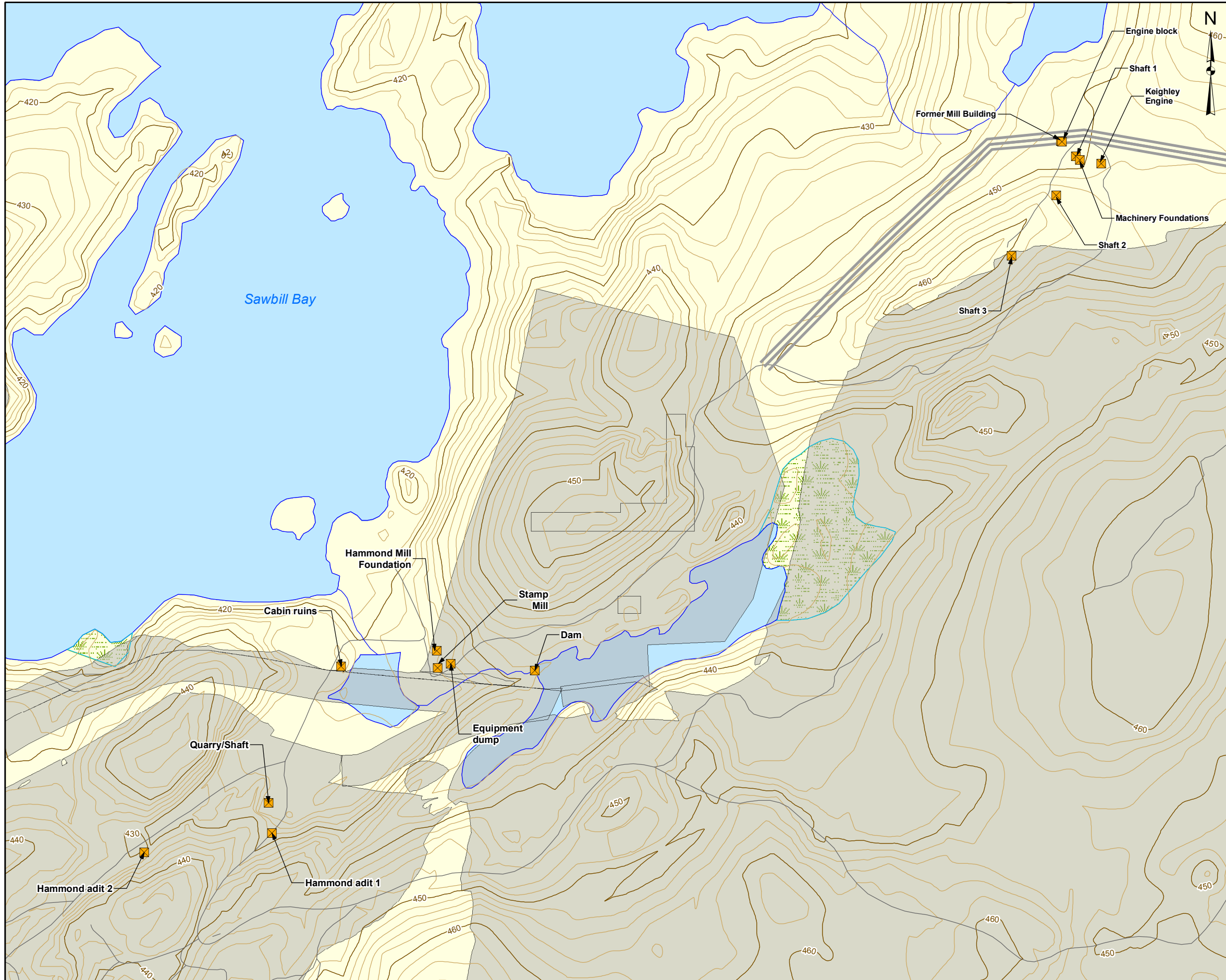

LEGEND

- Historic Mine Feature
- Mine Site Road
- Road
- Contours - 10m interval
- Contours - 2m interval
- River/Stream
- Lake
- Wetland
- Mine Facilities

INDEX MAP

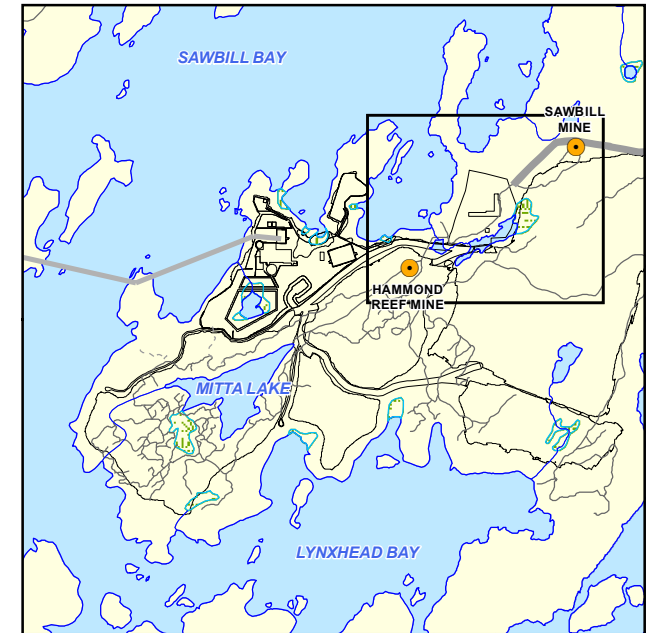

REFERENCE

Base Data - Provided by OSISKO Hammond Reef Gold Project Ltd.
 Base Data - MNR NRVIS, obtained 2004
 Produced by Golder Associates Ltd under licence from
 Ontario Ministry of Natural Resources, © Queens Printer 2008
 Projection: Transverse Mercator Datum: NAD 83 Coordinate System: UTM Zone 15N



PROJECT	HAMMOND REEF GOLD PROJECT ATIKOKAN, ONTARIO, CANADA		
TITLE	SITE PLAN		
Golder Associates Mississauga, Ontario	PROJECT NO:	1408383 (3100)	SCALE AS SHOWN
	DESIGN	CGE 14 Nov. 2008	REV. 0
	GIS	CGE 10 Dec. 2014	MAP: 1
	CHECK	MG 10 Dec. 2014	
	REVIEW	AA 10 Dec. 2014	



HAMMOND REEF HERITAGE PHOTOGRAPHIC DOCUMENTATION

2.0 HAMMOND REEF MINE

The Hammond Reef Mine was situated on the east shore of the upper part of Sawbill Bay in Marmion Reservoir (Figure 3) and about a kilometre southwest of the former Sawbill Mine (See Section 3). The term “reef” was apparently a local usage and derived from the presence of the shear zone that delineated the ore outcropping.⁴

James Hammond discovered a broad band of gold bearing rock in 1896. The property of the Hammond Reef mine originally consisted of nine locations divided between two companies. The Folger-Hammond Gold Reef Mines Company had seven claims (316X to 322X) while the Hammond Gold Reef Mining Company Limited, held two properties (337X and 338X). Both companies were controlled by the same investors. The owners soon realized that considerable capital expenditure was necessary to install a large mill and construct a hydroelectric power plant. Consequently, the two companies amalgamated as the Hammond Reef Consolidated Mining Company, Limited.⁵

A 10-stamp mill was installed on Claim 338X in 1897, and thirty stamps were added in 1899. Ore was obtained from both a ten metre deep open-cut and also underground from an 18 metre shaft. A crusher house with a Blake crusher of 200 tons/day capacity was constructed close to the pit, about 75 metres from the mill. In 1898, all work was confined to open pits, the underground work being abandoned. The ore was hauled by a tramway to the mill. There is a reference that this was an aerial tramway, rather than a tracked tramway, but it does not appear to have been completed. Mining was discontinued at the end of 1900 after the mill’s main motor was damaged.⁶

In 1928, the property was renamed the Rossmore Mine and owned by Copper Zinc Mines of Sudbury Limited. By c.1961, the property was acquired by Ventures Claims Limited, Toronto and, in turn, by Falconbridge in 1962.⁷

Five areas/features of the Hammond Mine site were documented on October 22, 2014:

- two mine adits;
- a rock cut;
- a log cabin;
- machinery debris piles and remnant concrete foundations; and
- a timber/rock dam.

⁴ Ontario. Ministry of Natural Resources, *Geology of the Finlayson Lake Area* Fenwick, 1976.

⁵ Ontario Bureau of Mines, *Annual Report, 1896.* “Third Report on the West Ontario Gold Region,” *Annual Report 1900.*

⁶ Ibid. *Annual Report 1899, Part One; Report 1900; Canada Geological Survey of Canada, Geology Of The Area Covered By The Seine River; Map Sheets.* Dept of Mines *Annual Report 1925, “Gold Deposits of Kenora and Rainy River Districts,” Annual Report 1921 Part 2, “Ontario Gold Deposits Their Character, Distribution and Productiveness.”*

⁷ Ontario Ministry of natural resources *Geology of the Finlayson Lake Area* Fenwick, 1976.



HAMMOND REEF HERITAGE PHOTOGRAPHIC DOCUMENTATION

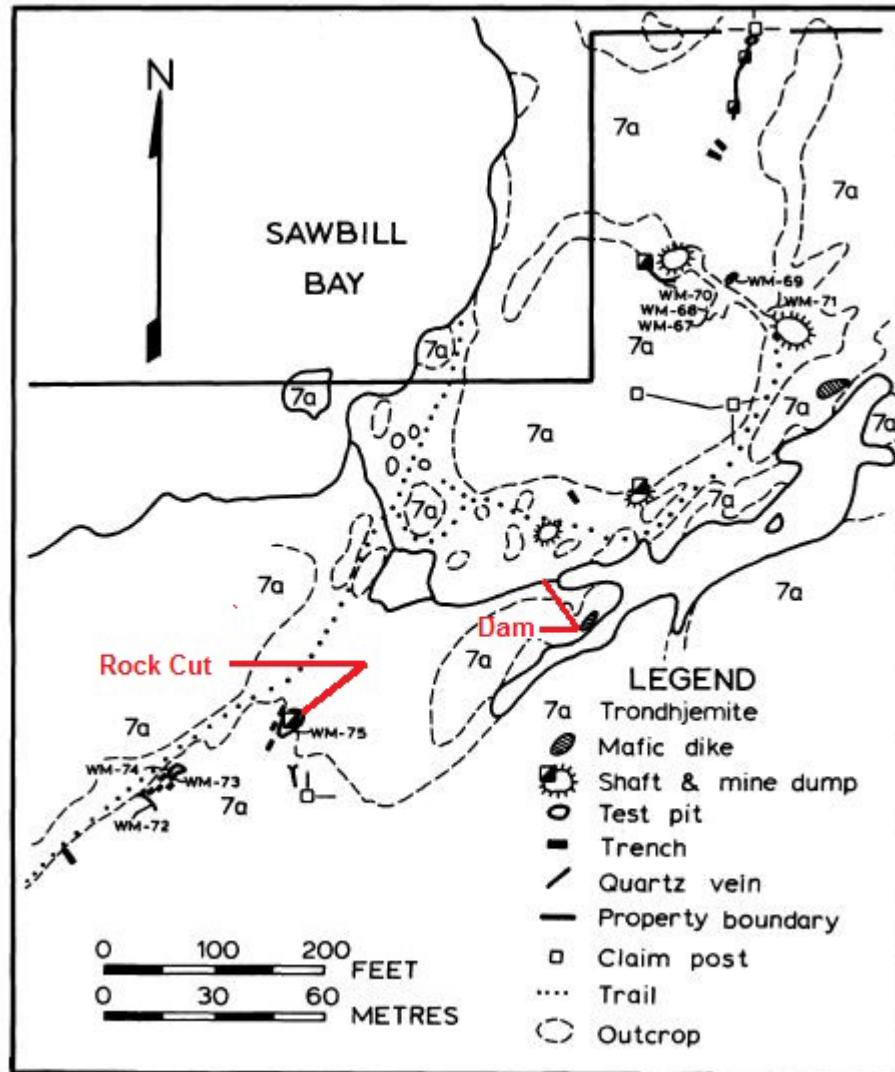

Figure 3: Geology of the Hammond Reef Mine showing location of rock cut (Section 2.2) and the timber dam (Section 2.5). (Ontario Ministry of Natural Resources. Geological Survey. Mineral Deposits Circular 24, Gold Deposits of the Atikokan Area, 1982)



HAMMOND REEF HERITAGE PHOTOGRAPHIC DOCUMENTATION

2.1 Mine Adits

The gold deposit when discovered in 1896 was described as “*probably low grade but very extensive.*” Initially ore was obtained from both an open-cut 10 metres deep and from an 18 metre shaft. But, by 1898, all work confined to open pits and underground mining abandoned.⁸ Open pit working was cheaper than shaft mining, as long as suitable quantities of ore were available at the surface.

Two short adits were identified on the Hammond Reef Property (Plates H-1 – H-4).⁹ They were close to the rock cut described in Section 2.2. These adits do not seem to have been used for mining and perhaps were driven to help identify areas for expansion of the open pit.

The adits were located about two metres above the base of the rock walls. Modern mine roads passed near the base of the adits. They were of similar cross section, approximately two metres high and 1.5 metres wide. Neither adit was tunneled far into the hillside; Adit One extended for about 10 metres and Adit 2 was somewhat longer but it was too dark to confirm the distance. Both entrances were blocked by fencing.

The following plates illustrate the condition of the features in 2014:

Plate H-1: Adit 1, showing the entrance about 2-3 metres above the base of the rock face

Plate H-2: Adit 1, Tunnel

Plate H-3: Adit 2, entrance photographed from modern mining road

Plate H-4: Adit, 2, Tunnel

⁸ Ontario Bureau of Mines, *Annual Report*, 1896. “Third Report on the West Ontario Gold Region;” *Annual Report* 1899, Part One; *Annual Report* 1900.

⁹ An adit (sometimes a drift) is a mining term for a nearly level tunnel



HAMMOND REEF HERITAGE PHOTOGRAPHIC DOCUMENTATION



Plate H-1: Adit 1, Entrance



HAMMOND REEF HERITAGE PHOTOGRAPHIC DOCUMENTATION



Plate H-2: Adit 1 looking from entrance with end of tunnel in rear



HAMMOND REEF HERITAGE PHOTOGRAPHIC DOCUMENTATION



Plate H-3: Adit 2, Entrance



HAMMOND REEF HERITAGE PHOTOGRAPHIC DOCUMENTATION



Plate H-4: Adit 2 looking from entrance; the end of tunnel is not visible



HAMMOND REEF HERITAGE PHOTOGRAPHIC DOCUMENTATION

2.2 Rock Cut

This feature, identified in Figure 3, was an open pit mine. It is characterized by vertical rock walls on two sides with a maximum height of about 5-8 metres. A large pond sits in front of the rock walls and possibly indicates that extraction occurred into a pit. The area between the pond and the road in the foreground appears to have been backfilled (Plate H-5). Adit 1 (Plate H-1) is just out of the view of the photograph on the left side.

Set back about a metre from the edge of the two rock faces were rows of drill holes (Plate H-6). These would have been filled with explosives and used to shatter of a layer of ore from the face of the quarry. Their presence suggests that future blasting activity had been anticipated along the face. Adjacent to the drill hole in the photograph are sawcuts that were used to remove channels of rock for testing as part of the modern property exploration.

Some distance from the drill holes, several iron rings, some with remnants of steel cable, had been driven into the rock (Plate H-7). These are assumed to have held guy ropes to support hoisting derricks to remove ore from the pit, or other mining equipment.

This rock face was the only confirmed area of mining noted in the field inspection. A second area was visited north-east of the mine claim on the road to Sawbill Mine. Although some vertical rock faces were noted, evidence of mining activity (drill holes, equipment, etc.) were not observed.

The following plates illustrate the condition of the features in 2014:

Plate H-5: Overview of Quarry/Shaft

Plate H-6: Looking Over Quarry Face with Drill Hole

Plate H-7: Looking Over Quarry Face with Iron Ring



HAMMOND REEF HERITAGE PHOTOGRAPHIC DOCUMENTATION



Plate H-5: Overview of Rock Cut with pond in foreground



HAMMOND REEF HERITAGE PHOTOGRAPHIC DOCUMENTATION



Plate H-6: Looking Over Quarry Face with Drill Hole



HAMMOND REEF HERITAGE PHOTOGRAPHIC DOCUMENTATION



Plate H-7: Looking Over Quarry Face with Iron Ring



HAMMOND REEF HERITAGE PHOTOGRAPHIC DOCUMENTATION

2.3 Log Cabin

A small log cabin was examined on a rock ridge roughly half way between the rock cut (Section 2.2) and the mill site (Section 2.4). It is assumed to date from the 1890s mining era but there was no direct evidence of this assumption.

The building was small, about 20 by 16 feet (6.1 by 4.9 metres). The roof and most of the walls had collapsed. The corners suggest it was quite simply constructed (Plate H-8). Metal shingles were found on the ground surrounding the cabin.

The only identifiable component were the cast iron plates from a wood stove with the casting “HAZELWOOD” on one of the plates (Plate H-9, H-10). The HAZELWOOD brand of stoves was manufactured by the Gurney Foundry in Hamilton at least during the 1890s. An identical casting was found at the Sawbill Mine during the 2011 Golder archaeological fieldwork.

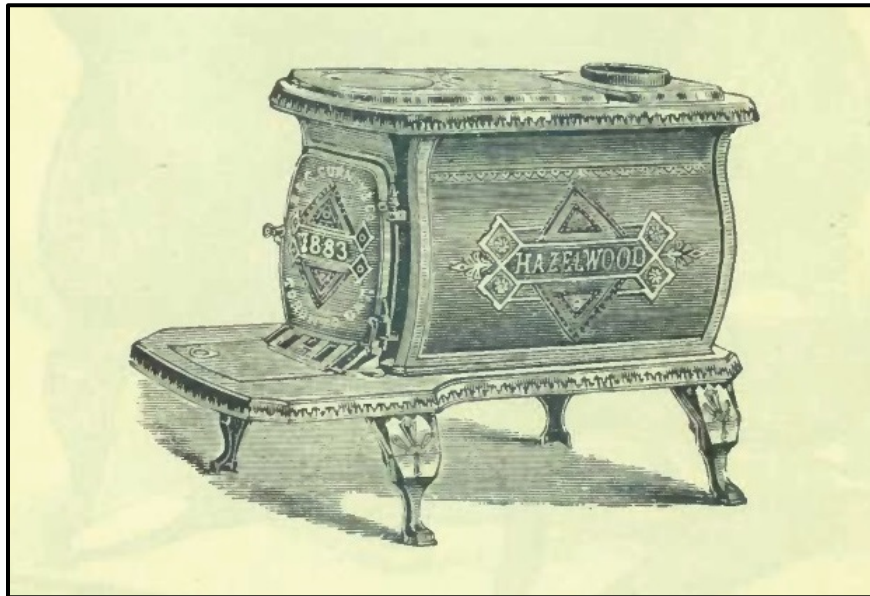

Figure 4: HAZELWOOD wood stove from 1892 Gurney Catalogue, Hamilton Ontario.

The following plates illustrate the condition of the log cabin features in 2014:

- Plate H-8: Mine cabin, corner joints
- Plate H-9: Mine cabin, stove parts
- Plate H-10: Mine cabin, side casting of wood stove



HAMMOND REEF HERITAGE PHOTOGRAPHIC DOCUMENTATION



Plate H-8: Mine cabin, corner joints



HAMMOND REEF HERITAGE PHOTOGRAPHIC DOCUMENTATION



Plate H-9: Mine cabin, stove parts



HAMMOND REEF HERITAGE PHOTOGRAPHIC DOCUMENTATION



Plate H-10: Mine cabin, side casting of wood stove



HAMMOND REEF HERITAGE PHOTOGRAPHIC DOCUMENTATION

2.4 Mill Location

The specific location of the mill building is unknown (Figure 5). The only indicator of the operation is a dump of pulleys, stamp mills, other equipment and concrete foundations that have been bulldozed up to the base of a hill (Plates H-12 – H-14). The trees and amount of leaf litter suggest that this “clean-up” occurred two or three decades, or more, ago. In front of this slope, and stretching to the rock ridge on which the cabin (Section 2.3) is located is an artificially flat area (Plate H-11). The mill is assumed to have been somewhere on this plot. Most recently the location had been used by the mining company for core sample storage.



Figure 5: Hammond Reef Mine - Mill House - What Appears to be Aerial Tramway on Roof. (Source: Atikokan Museum)

Figure 6 shows the basic layout of a late 19th century stamp mill. In this figure, the mill is built into a hillside so that ore was moved through the building by gravity. The Hammond Reef mill was a free standing structure which accounts for its height needed for gravity feed. Ore was received from the mine on a tramway and dumped into a chute to the primary crusher.

The primary crusher reduced the ore to smaller size which fell into a storage bin below. The storage bin fed the stamp mill. The stamp mill pulverized the ore to a fine powder. Visually, the stamp mill is the piece of equipment commonly associated with late 19th century gold mining (Figures 8-11). Remnants of stamp mills were noted at the Hammond Reef property (Plate H-12). The ore was mixed with water during the stamping process and the resulting slurry flowed through a trough to amalgamating plates where the gold was chemically separated from the rock.

The following plates illustrate the condition of the mill features in 2014:

Plate H-11: Overview of modern grading

Plate H-12: Possible stamp mill box



HAMMOND REEF HERITAGE PHOTOGRAPHIC DOCUMENTATION

Plate H-13: Two pulleys on axle

Plate H-14: Concrete machinery base

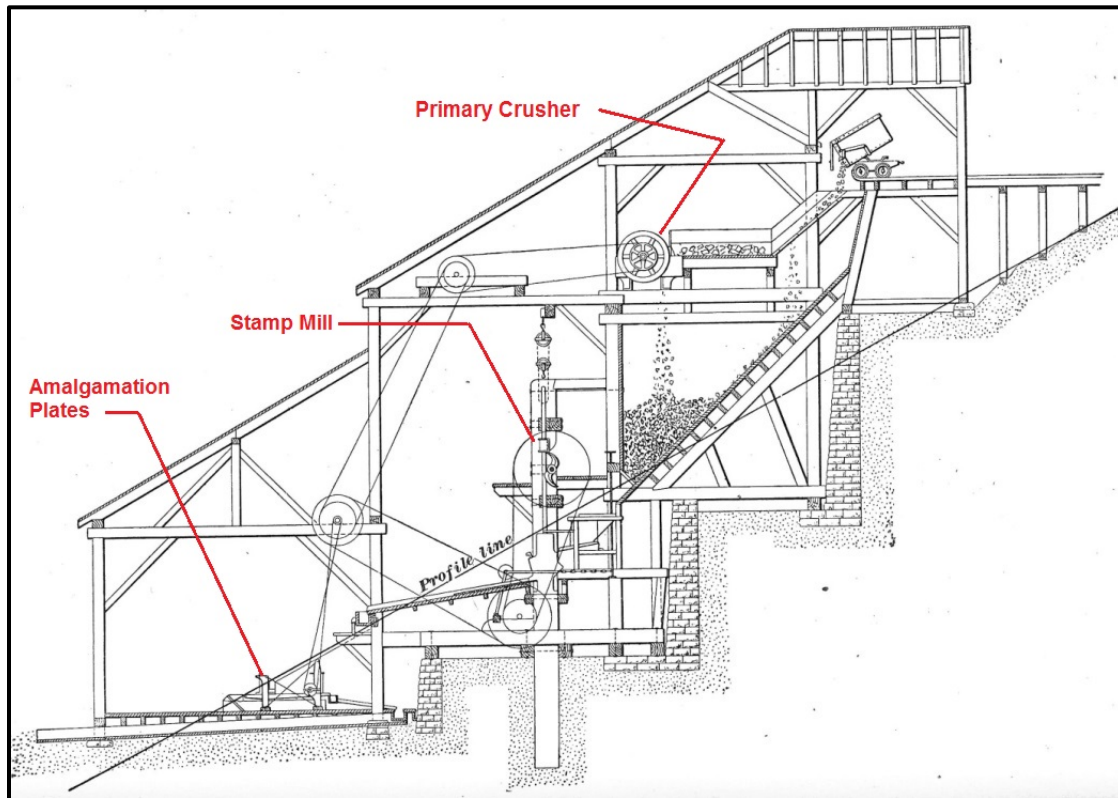

Figure 6: Cross Section of mill building using gravity feed. (Source: International Textbook Company, A Textbook on Metal Mining 1899)



HAMMOND REEF HERITAGE PHOTOGRAPHIC DOCUMENTATION

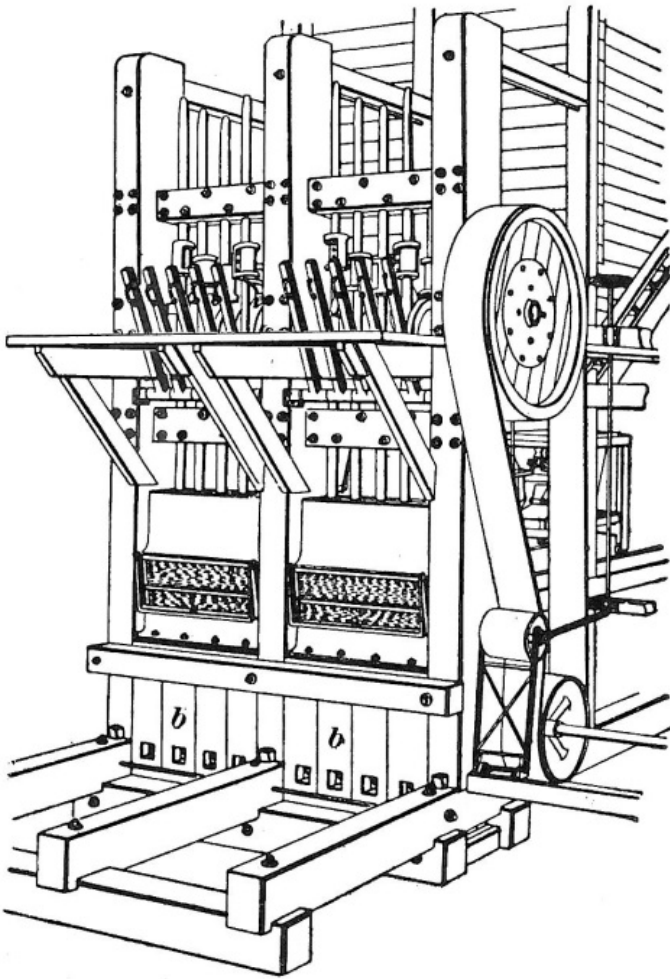

Figure 7: Typical stamp mill (left) with two sets of five stamps (Source: International Textbook Company, A Textbook on Metal Mining 1899)



Figure 8: Mining, Stamp Mill (right), originally from the Golden Winner Gold Mine and relocated to park. Atitokan Historical Park Oct 23, 2014



HAMMOND REEF HERITAGE PHOTOGRAPHIC DOCUMENTATION



Figure 9: Mining, Stamp Mill, Atikokan Historical Park, Oct 23, 2014

Figure 10: Stamp Mill Box (Source: *International Textbook Company, A Textbook on Metal Mining 1899*)

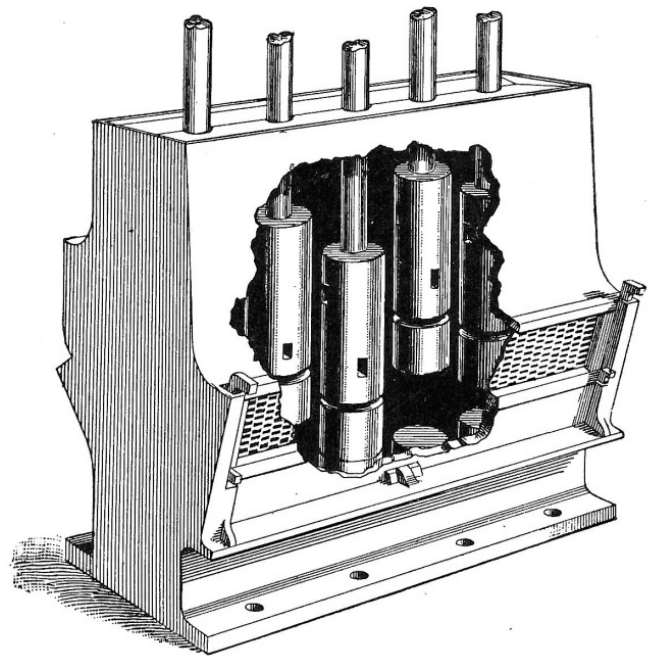



HAMMOND REEF HERITAGE PHOTOGRAPHIC DOCUMENTATION



Plate H-11: Overview of mill site showing modern grading



HAMMOND REEF HERITAGE PHOTOGRAPHIC DOCUMENTATION



Plate H-12: Stamp mill box



HAMMOND REEF HERITAGE PHOTOGRAPHIC DOCUMENTATION



Plate H-13: Two pulleys on axle with the equipment dump



HAMMOND REEF HERITAGE PHOTOGRAPHIC DOCUMENTATION



Plate H-14: Concrete machinery base with notebook for scale



HAMMOND REEF HERITAGE PHOTOGRAPHIC DOCUMENTATION

2.5 Hammond Reef Timber Dam

In 1897 the company built a dam above the mill to create a pond to provide boiler water. However, the water proved unsuitable for this use and the pond was abandoned. Water was instead pumped from Sawbill Lake.¹⁰ The design was typical of small, 19th-century mill dams (Figure 12). The steeply sloped vertical boards on the upstream side provided a water proof barrier (Plate H-13). The rock on the downstream side provided ballast to stabilize the dam (Figure 11). By 2014 the former pond above the dam had silted in as a beaver meadow



Figure 11: Close Up of Timber Crib Dam Structure, October 2011 (Source Golder Stage 1 Baseline Study and Stage 2 Archaeological Assessment 2013).

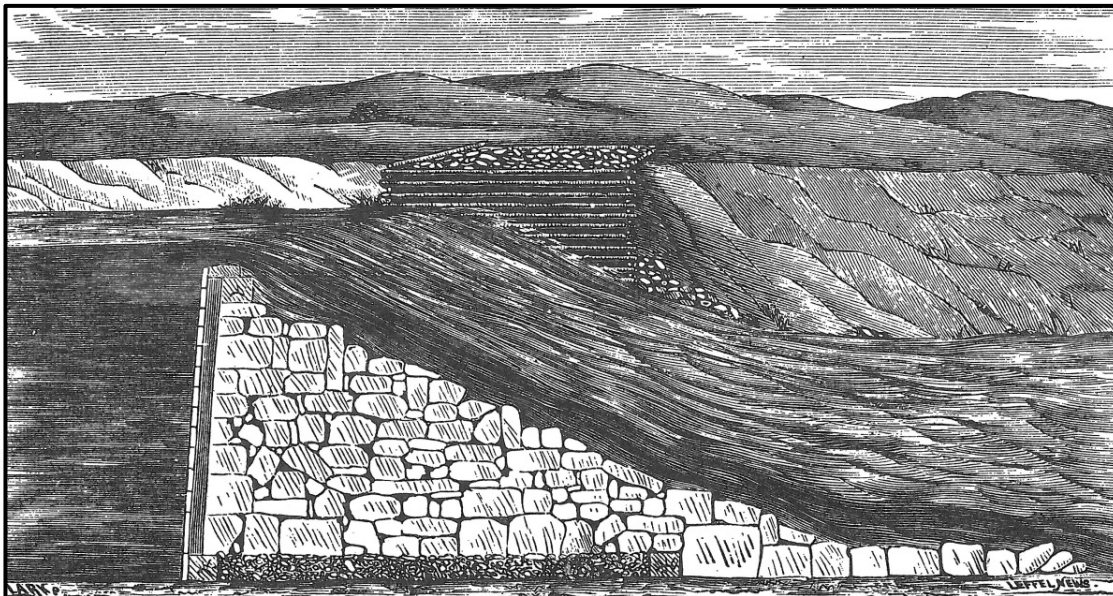

Figure 12: Sketch of timber dam (Source: James Leffel Construction of Mill Dams 1881, Reprint Noyes Press, 1972)

¹⁰ Ontario Bureau of Mines. *Annual Report 1899, Part One; Report 1900.*



HAMMOND REEF HERITAGE PHOTOGRAPHIC DOCUMENTATION



Plate H-15: Overview of dam showing timber framing on upstream side

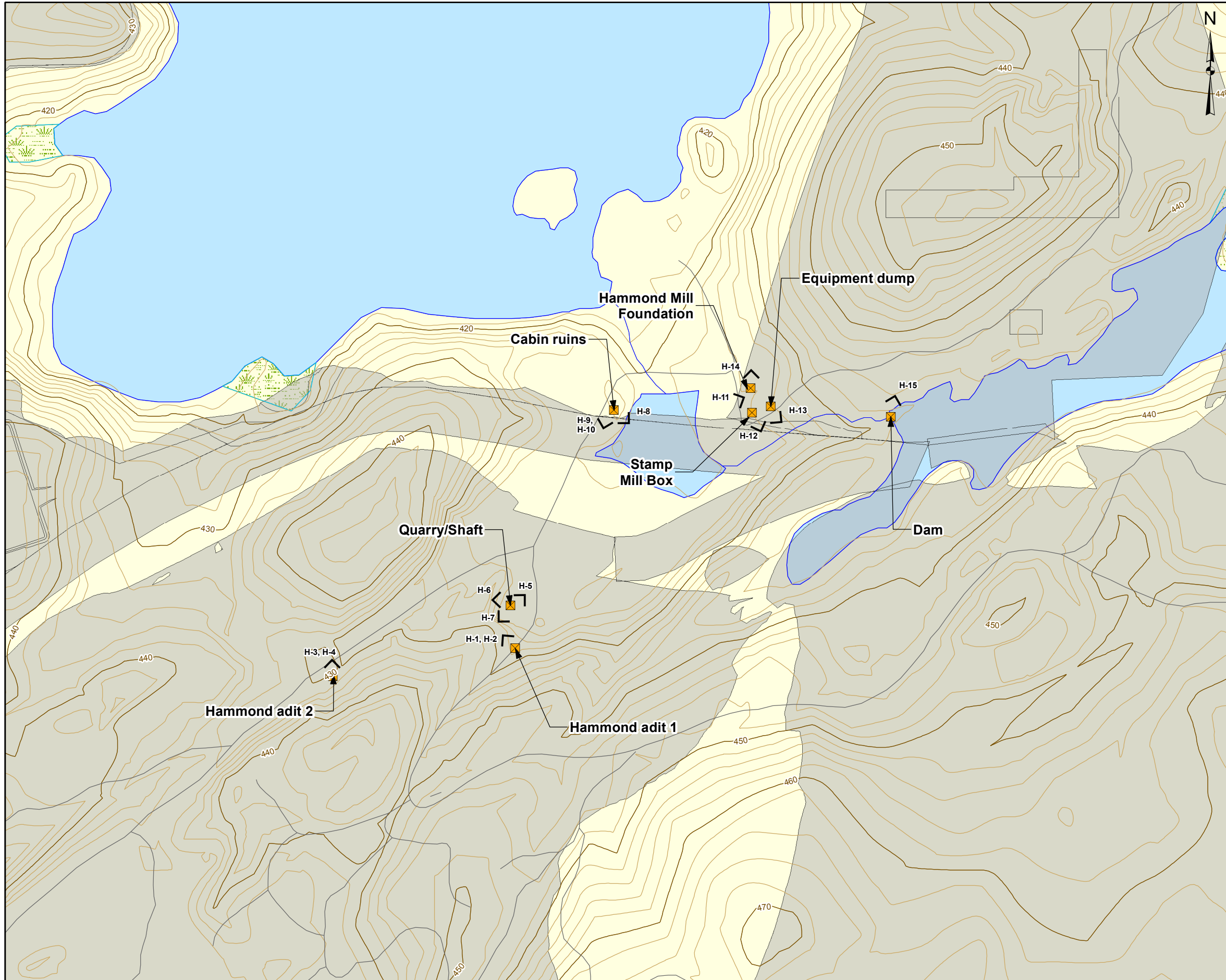

LEGEND

- Historic Mine Feature
- H-1 Photo Location and Direction
- Mine Site Road
- Road
- Contours - 10m interval
- Contours - 2m interval
- River/Stream
- Lake
- Wetland
- Mine Facilities

INDEX MAP

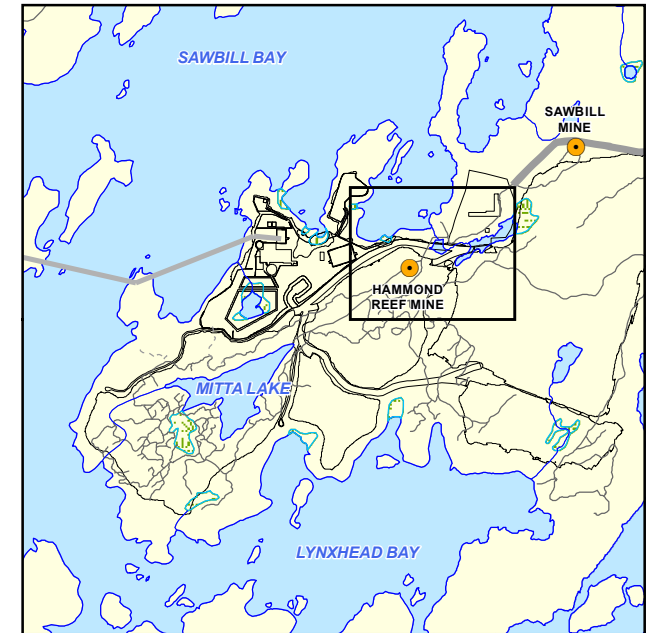

REFERENCE

Base Data - Provided by OSISKO Hammond Reef Gold Project Ltd.
 Base Data - MNR NRVIS, obtained 2004
 Produced by Golder Associates Ltd under licence from
 Ontario Ministry of Natural Resources, © Queens Printer 2008
 Projection: Transverse Mercator Datum: NAD 83 Coordinate System: UTM Zone 15N

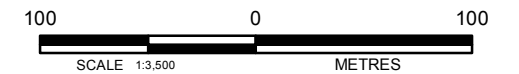

PROJECT	HAMMOND REEF GOLD PROJECT ATIKOKAN, ONTARIO, CANADA		
TITLE	HISTORIC FEATURES - HAMMOND MINE		
Golder Associates Mississauga, Ontario	PROJECT NO:	1408383 (3100)	SCALE AS SHOWN
	DESIGN	CGE 14 Nov. 2008	REV. 0
	GIS	CGE 10 Dec. 2014	MAP: 2
	CHECK	MG 10 Dec. 2014	
	REVIEW	AA 10 Dec. 2014	



HAMMOND REEF HERITAGE PHOTOGRAPHIC DOCUMENTATION

3.0 SAWBILL MINE

The Sawbill Mine was first mentioned in an Ontario Government report in 1895, where it is remarked that the Wiley brothers had discovered a vein on Sawbill Lake. The Sawbill Lake Gold Mining Company Limited was incorporated in May 1896. The Company owned mining locations 313X and 314X with the mine on 313X. Work began in April, 1895 and at the end of 1896 'the main shaft had been sunk 45 metres. At 18 metres a "60 foot" level was cut south along the vein and at 87 metres a "120 foot" level was run (Figure 16).¹¹

The ore potential on Claims 313X and 314X was visible as a quartz vein one-two metres wide. A 10-stamp mill was erected and commenced operation in October, 1897, but very little gold was recovered and mining ceased by the end of the year.¹²

The vein on which the mine was worked lay about a half kilometre inland, and a shaft was sunk in a depression between two hills at an elevation of about 45 metres above the lake. The vein where the shaft begins was about a metre wide and can be followed for about a half kilometre. Ore was brought up in buckets and dumped into a tramcar. By January 1896 the main shaft had reached a depth of about 40 metres. Drifts were driven at the "60-foot" and "120-foot" levels. The ore was processed with a ten-stamp mill.¹³

In 1896 the manager was F. S. Wiley, and George Willoughby was the mine engineer. At the shaft, there was a 22-horsepower hoist and, a 25-horsepower boiler. The shaft was drained by two steam pumps, although at the time of the mining inspector's visit, the small amount of water entering the shaft was raised in buckets.¹⁴

Fourteen men were then employed to haul supplies from Bonheur. The cooking and sleeping camps, an office, storehouse and stable, "all of an inexpensive character" where located on the lake shore.¹⁵

About 60 metres south of No. 1 shaft was a second vertical shaft, which was connected to the lateral workings from No. 1 shaft on the "50-foot" level. On the "240-foot" level, north of No. 1 shaft, a winze was sunk to a further depth of 15 metres. Stopping was carried on north and south of No. 1 shaft on the "50-foot" and "100-foot" levels.¹⁶

The mine was closed from March until August, 1898. Then on September 20, while drilling at the bottom of the shaft a considerable flow of water was struck that continued for months, flooding the lower part of the shaft and preventing further development. A drift was driven along the vein at the "220-foot" level, and a winze sunk so that additional pumps could finally drain the water and shaft sinking continued.¹⁷

While the underground work was closed, the company continued to extract ore from open pits. About 250 metres north of the shaft, a 25 metre crosscut was blasted out and 1,000 tons of ore removed. A few hundred

¹¹ Ontario Ministry of Natural Resources *Geology of the Finlayson Lake Area* Fenwick 1976

¹² Ontario Dept. of Mines, *Annual Report* 1921 Part 2, "Ontario Gold Deposits Their Character, Distribution and Productiveness".

¹³ Ontario Bureau of Mines, *Annual Report*, 1896."Third Report on The West Ontario Gold Region

¹⁴ Ibid.

¹⁵ Ibid

¹⁶ Dept. of Mines *Annual Report*, 1939, Part 1,1939.

¹⁷ Ontario Bureau of Mines *Annual Report* 1900; Dept. of Mines Report 1925 "Gold Deposits of Kenora and Rainy River Districts."



HAMMOND REEF HERITAGE PHOTOGRAPHIC DOCUMENTATION

metres south of the main shaft three test-pits were sunk on outcroppings of what appears to be an extension of the Hammond Reef.¹⁸

By October 1900, mining had stopped again. The option under which the mine was being worked by a syndicate had expired and all the men were discharged.¹⁹

Mining did not resume until the 1930s. In 1936-1937 the Upper Seine Gold Mines, Limited carried on surface exploration work and did some diamond-drilling. During the first six months of 1938 about 100 metres of drifting was done on the third level, and 150 metres of surface-trenching, was undertaken. Mining operations were suspended in June. A 50-ton amalgamation mill, formerly in use at the property of Hudson-Patricia Gold Mines, Limited, was purchased and installed in 1939. Other equipment included a Blake jaw crusher, a ball mill, a Denver jig, and a Dorr rake classifier, corduroy blankets, and amalgam plates. The following buildings were erected: mill, blacksmith shop, magazine, caphouse, cook-house, ice-house, office, and an addition to the boiler-house. Dewatering of the mine began in 1937 but was not completed until 1941. Underground mining resumed for a few months but ended in September.²⁰



Figure 13: No. 2 shaft, Elizabeth Mine, in 1937. The mine was controlled by the same owners as the Sawbill Mine. It is assumed that the Sawbill Mine property would be of a similar character. (Source: Ontario Dept. of Mines, Geology and Ore Deposits of the Atikokan Area, 1939.)

¹⁸ Ontario Bureau of Mines *Annual Report* 1900

¹⁹ *Ibid.* 1899, Part One, 1900.

²⁰ *Ibid.*, 1937, Part 1 Mines in Ontario p.222-3; *Annual Report* 1939; Part 1; *Annual Report* 1941, p.140,



HAMMOND REEF HERITAGE PHOTOGRAPHIC DOCUMENTATION

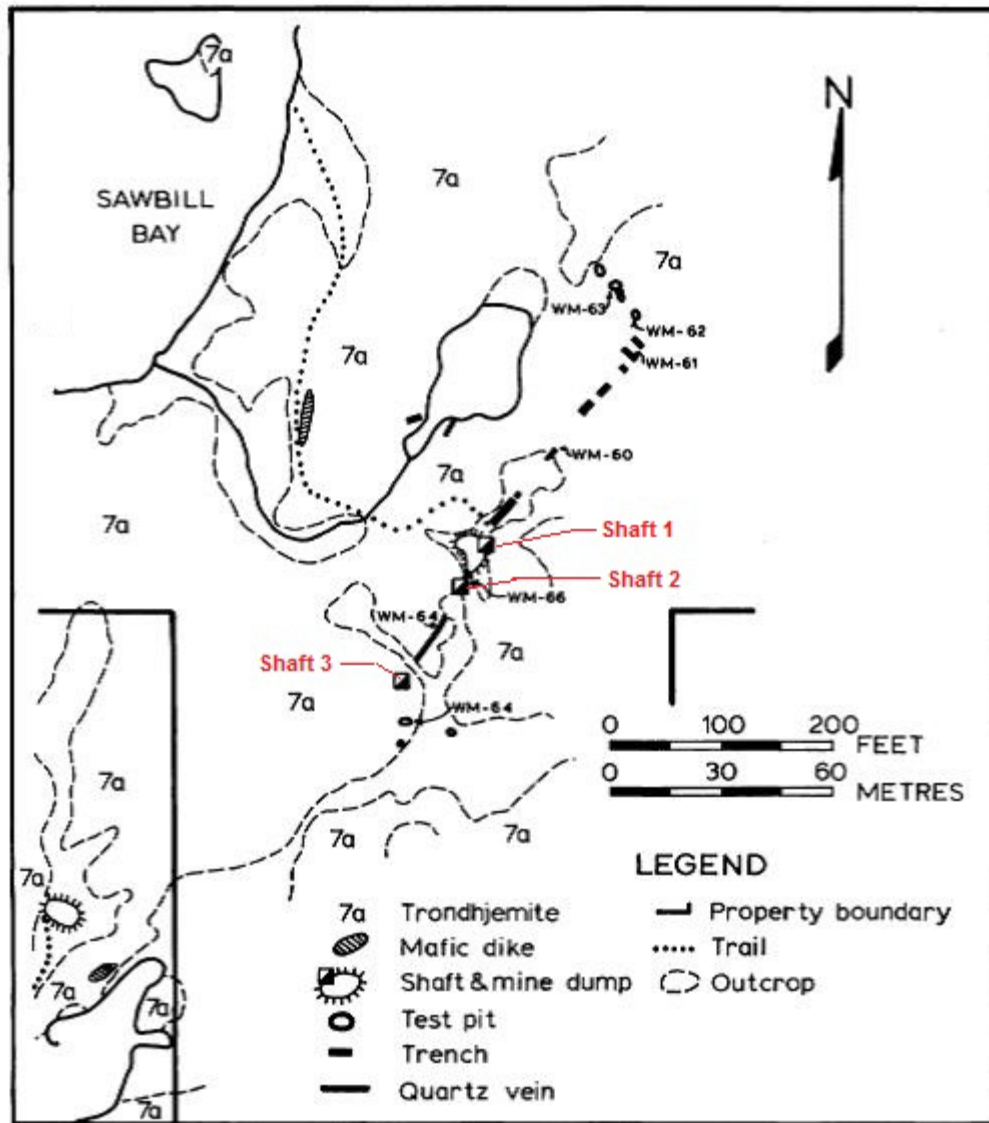

Figure 14: Geology of the Sawbill Mine. (Source: Ontario Ministry of Natural Resources. Ontario Geological Survey. Mineral Deposits Circular 24, Gold Deposits of the Atikokan Area, 1982)

Three groups of historic features were documented at the Sawbill Mine site on October 21, 2014:

- Mine shafts 1, 2, and 3;
- Concrete foundations of former mill building and remnant earthworks of a mine tramway; and
- Keighley oil engine.



HAMMOND REEF HERITAGE PHOTOGRAPHIC DOCUMENTATION

3.1 Mine Shafts

Three water filled shafts were documented and, for the purposes of this assessment identified as Shafts 1 to 3 (Plate S1-S5). The shafts had been surrounded with temporary snow fencing by the current mining company as a safety measure. Overburden has been stripped to bedrock to expose the outcropping of the ore body (Plate S1). Shaft 1 (Plate S2, S3) was the material and personal shaft. Shafts 2 and 3 were for ventilation (Plate S4, S5). Concrete foundations of the former mill building are visible in the background of Plate S-2 (See Section 3.2). The former mine engine is located in the trees to the right of Shaft 1 (See Sections 3.3).

Mining commenced in April, 1895 and by the end of 1896 'the main shaft had been sunk to 44 metres (145 feet) and the "60 foot" and "120 foot" levels were excavated.²¹ Shaft One, with the headframe, is located in the centre of Figure 16 and Shaft 2 is to the left. The outline of the hoist house is similar to that depicted at the Elizabeth Mine in Figure 13.

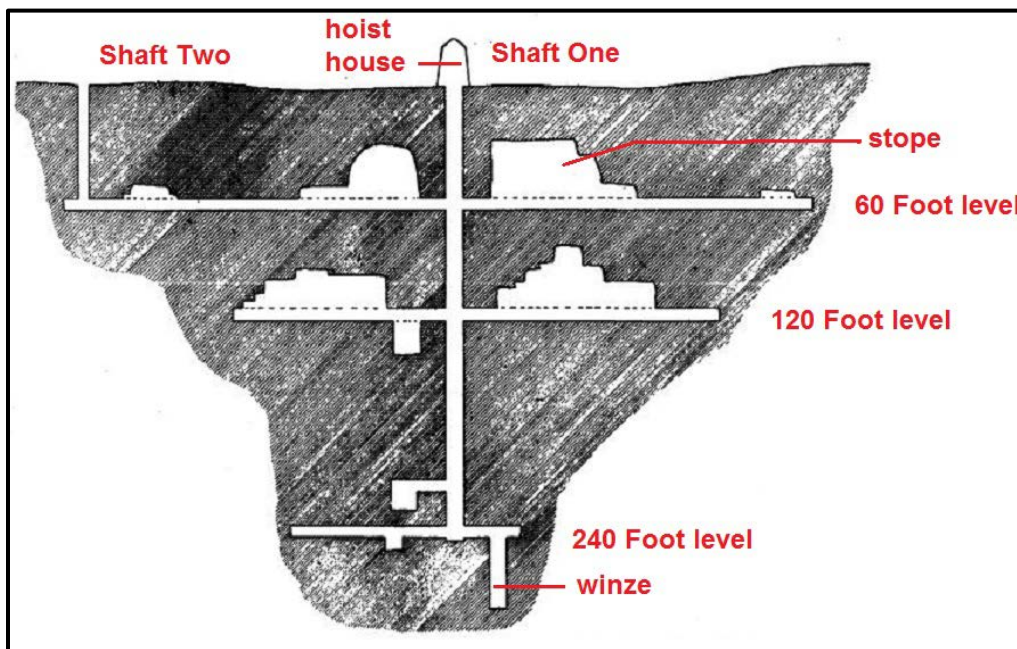

Figure 15: Sawbill mine c 1900. (Ontario Department of Mines Annual Report 1921, Part 2 Ontario Gold Deposits Their Character, Distribution and Productiveness; mine section was originally published in 1900 Annual Report)

Mining produced considerable amounts of waste rock that was usually dumped close to the hoist house. No rock dump was observed at the Sawbill Mine. However, a rubble field is visible in directly behind, and left of, the fencing in Plate S-2 may have been the rock dump that was re-graded during subsequent exploration work in the late 20th century; the rock appears to be a causeway across a small valley.

Shaft One is rectangular in shape and filled with water. Plate S-3 illustrates one remaining shaft timber at the water level and light-weight tramway rails protruding vertically out of the shaft on the left. The rectangular shape

²¹ Ontario Ministry of Natural Resources *Geology of the Finlayson Lake Area* Fenwick 1976



HAMMOND REEF HERITAGE PHOTOGRAPHIC DOCUMENTATION

was typical for shaft framing of the era. Figures 16 and 17 illustrate the type of system that appears to have been used at Sawbill. In this example, the shaft has been framed to contain two cage ways for men and materials and a pump way to contain pipes that drained the mine.

Shafts Two and Three were roughly square and smaller than Shaft One but also water filled.

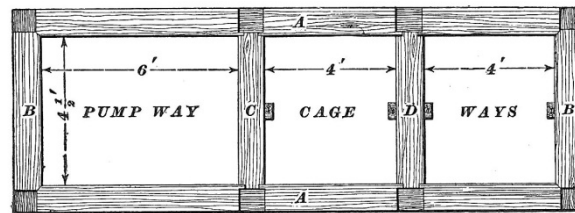

Figure 16: Plan of mine shaft framing for a pump way and two cage ways. (Source: International Textbook Company, A Textbook on Metal Mining 1899)

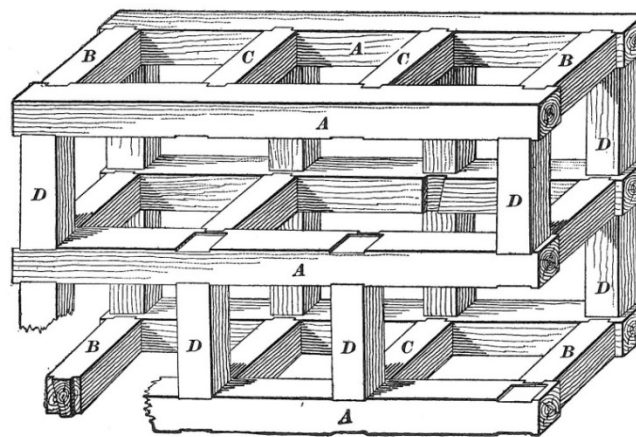

Figure 17: Isometric view of shaft timber framing. (Source: International Textbook Company, A Textbook on Metal Mining 1899)

The following plates illustrate the condition of the three mine shaft features in 2014:

- Plate: S-1: Looking north from Shaft Three towards Shaft Two in middle and Shaft One in rear; the exposed bedrock traces the strike of the gold vein
- Plate: S-2: Shaft 1, looking west from Keighley Engine
- Plate: S-3: Shaft 1, looking north showing mine timber and tramway rails
- Plate: S-4: Shaft 2
- Plate: S-5: Shaft 3, looking south and up slope to shaft



HAMMOND REEF HERITAGE PHOTOGRAPHIC DOCUMENTATION



Plate S-1: Looking north from Shaft Three towards Shaft Two in middle and Shaft One in rear



HAMMOND REEF HERITAGE PHOTOGRAPHIC DOCUMENTATION



Plate S-2: Shaft One, looking west towards concrete ruins of mill building



HAMMOND REEF HERITAGE PHOTOGRAPHIC DOCUMENTATION



Plate S-3: Shaft One showing water in shaft, mine timber (right) and tramway rails (left)



HAMMOND REEF HERITAGE PHOTOGRAPHIC DOCUMENTATION



Plate S-4: Shaft Two



HAMMOND REEF HERITAGE PHOTOGRAPHIC DOCUMENTATION



Plate S-5: Shaft Three looking south and up slope to the shaft



HAMMOND REEF HERITAGE PHOTOGRAPHIC DOCUMENTATION

3.2 Mill Building Foundations

The remains of the mill building were located near the head of a small valley. The overall size was approximately 15m by 20m. The mill floors were built as a series of four distinct levels that descended down the side of the valley wall. The change in elevation between the floors was too low to assume that the mill used gravity feed – such as used at the Hammond Reef Mine.

The original 1897 Sawbill mine had a stamp mill and would be similar (but smaller) to that at Hammond Reef (Figure 5) but by the 1920s ball mills had come into use to replace stamp mills, and a more horizontal mill built that did not have the high elevation and gravity feed. By the 1930s crushing and material handling equipment had changed. Within the Sawbill ruins, the heaviest concrete pedestals were located at the highest level of the ruins and they are assumed to be the location of primary crushers or ball mills (Plate S-6). On the basis of the design of the foundations and equipment blocks it is assumed that this ruin represents the second, 1930s mining effort.

Two concrete tanks were built into the floor of the lowest level of the mill (Plate S-8). The purpose of the tanks was not determined.

Although there is no documentary evidence to support this hypothesis, it is possible that the mill was powered by electricity. The large Keighley diesel engine, described in Section 3.3 was too far from the mill to provide mechanical power by belts or a ropeway. In addition, there was no evidence of a large steam engine base adjacent to the mill building to provide local mechanical power. It is speculated that the diesel drove a generator that provided mine power. Curiously when the mine reopened in 1936/1937, there is reference to “*an addition to the boiler-house*” but no reference to electric power.²²

The following plates illustrate the condition of the features in 2014:

Plate S-6: Mill foundations overview looking from Shaft One. The heavy concrete foundations and equipment pedestals are on the right rear, on the highest level of the mill.

Plate S-7: Concrete pedestals used to support pillow-blocks for pulley shafts. The large concrete base in the ear may have been the foundations for an electric motor (or small steam engine). The fencing around Shaft One is visible in the rear.

Plate S-8: Two concrete tanks on the lowest level

²² Ontario Bureau of Mines., 1937, Part 1 Mines in Ontario p.222-3; *Annual Report 1939*; Part 1; *Annual Report 1941*,p.140,



HAMMOND REEF HERITAGE PHOTOGRAPHIC DOCUMENTATION



Plate S-6: Mill foundation overview looking from Shaft One



HAMMOND REEF HERITAGE PHOTOGRAPHIC DOCUMENTATION



Plate S-7: Concrete footings for pillow blocks, looking towards Shaft One



HAMMOND REEF HERITAGE PHOTOGRAPHIC DOCUMENTATION



Plate S-8: Two concrete tanks on lowest level of mill foundation



HAMMOND REEF HERITAGE PHOTOGRAPHIC DOCUMENTATION

3.3 Keighley Engine

A large two-cylinder oil (diesel) engine was located on a rock ridge approximately 50m from Shaft One (Plates S9-S16).²³ The name *Imperial - Keighley* is cast into the cylinder heads (Plate S – 13). The Keighley Company manufactured oil and gas engines in the early 20th century at Keighley, England. Since the company began manufacturing diesel engines only in c.1905, the engine would have been installed as part of the 1930s mine reopening. *Imperial* was the company's brand name for this type of engine.

Visually, the engine is the most distinct feature on the Hammond Reef property. Its size, prominent position, and that it was the only virtually complete piece of historic equipment on the mine property in 2014 make it a well-known artifact. The tall, self-supporting exhaust pipe is threaded into the exhaust manifold. It is remarkable that it has survived 80 plus years (Plate S-10).

Placement of the engine far from Shaft One and the mill building suggests that it did not mechanically power equipment by means of belts or ropes. Most likely, it powered a generator that in turn provided electricity to the mine. An immense concrete foundation that lines up with the pulley from the engine was likely the location of the generator (Plate S-19). There is no documentary evidence of the use of electricity in the mine in the 1930s

The engine crank shaft connects to an approximately eight-foot (2.4 metre) cast iron flywheel, the remnants of a similar sized wooden pulley and two small diameter metal pulleys (Plates S-14, S-16). The wooden pulley lines up with the foundations in front of the engine (Plate S-19).

Adjacent to the large concrete foundation was a small steam engine. The machine seems to have been moved to the location rather than to be in its operating location. Asbestos jacketing was visible around the cylinder head. (Plates S17, S-18).

The following plates illustrate the condition of the features in 2014:

Plate: S-9: Keighley Engine, looking up the slope of rock ridge to north side of engine

Plate: S-10: Keighley Engine, with the exhaust stack west/south sides

Plate: S-11: Keighley Engine, south side of engine and base of exhaust stack

Plate: S-12: Keighley Engine, east side with crank shaft, with positioning wheel to rotate flywheel to align pistons to start engine

Plate: S-13: Keighley Engine, cylinder heads and exhaust pipe base

Plate: S-14: Keighley Engine, north and east sides showing power-takeoff pulleys

Plate: S-15: Keighley Engine, flywheel showing positioning wheel and teeth in flywheel.

Plate: S-16: Keighley Engine, flywheel and remnants of wooden pulley with smaller steel pulley on right

Plate: S-17: Layout of equipment west of engine. The exhaust pipe base is on right; concrete footing for assumed generator is centre rear, and small steam engine and concrete pad in centre

²³ Oil engine was a British term but largely replaced with the term diesel engine in the early 20th century.



HAMMOND REEF HERITAGE PHOTOGRAPHIC DOCUMENTATION

Plate: S-18: Small steam engine and large concrete base close up

Plate: S-19: Large concrete footing west of engine with timber frame on left side; assumed to be generator base. Portion of the Keighley Engine visible on left.

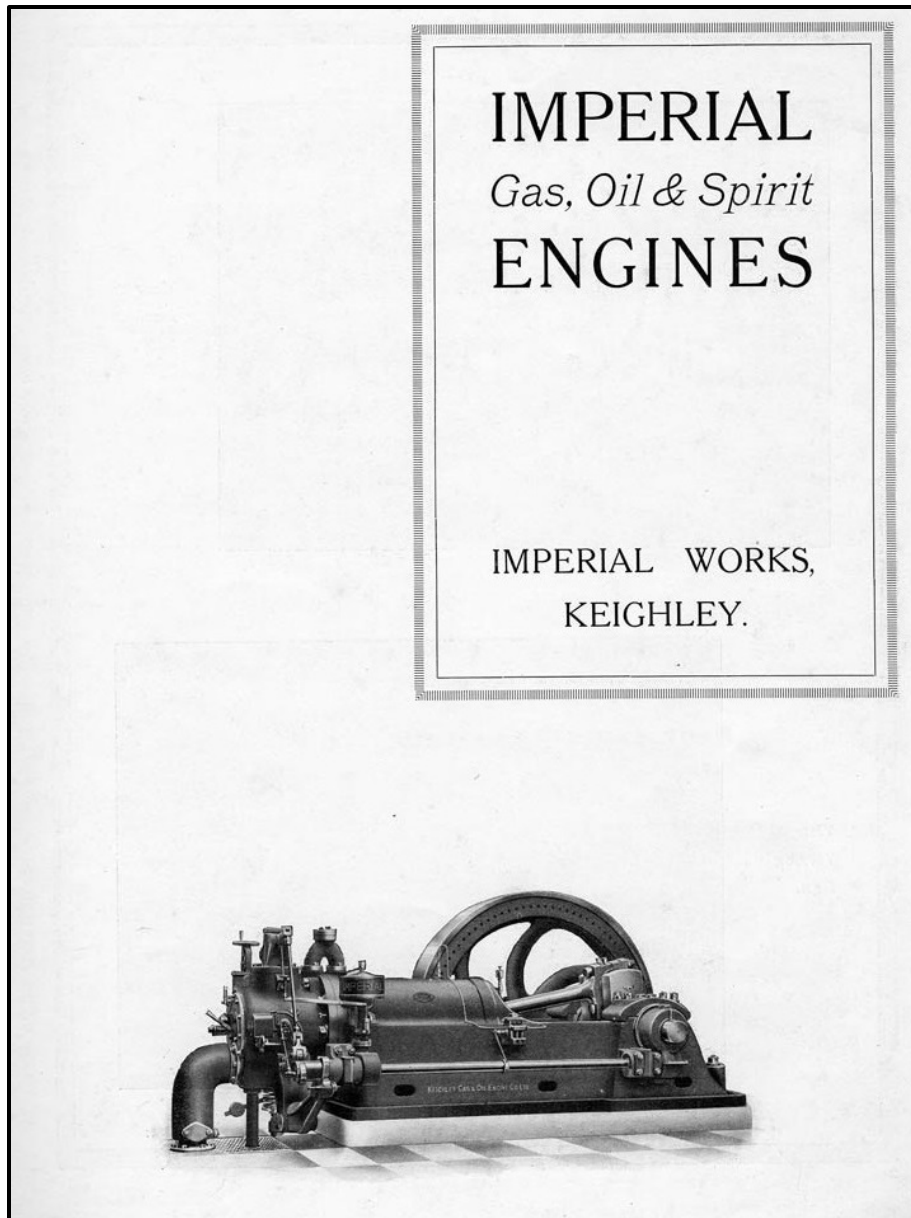

Figure 18: Keighley Gas & Oil Engine Catalogue - no date cover. Illustrates a single cylinder model but otherwise similar in design. (Source: Rural History Centre, The University of Reading UK [www.rhc.rdg.ac.uk])



HAMMOND REEF HERITAGE PHOTOGRAPHIC DOCUMENTATION



Plate S-9: Keighley Engine, north side



HAMMOND REEF HERITAGE PHOTOGRAPHIC DOCUMENTATION



Plate S-10: Keighley Engine, south side



HAMMOND REEF HERITAGE PHOTOGRAPHIC DOCUMENTATION



Plate S-11: Keighley Engine, south side



HAMMOND REEF HERITAGE PHOTOGRAPHIC DOCUMENTATION



Plate S-12: Keighley Engine, east side



HAMMOND REEF HERITAGE PHOTOGRAPHIC DOCUMENTATION



Plate S-13: Keighley Engine, west side



HAMMOND REEF HERITAGE PHOTOGRAPHIC DOCUMENTATION



Plate S-14: Keighley Engine, east side



HAMMOND REEF HERITAGE PHOTOGRAPHIC DOCUMENTATION



Plate S-15: Keighley Engine, flywheel



HAMMOND REEF HERITAGE PHOTOGRAPHIC DOCUMENTATION



Plate S-16: Keighley Engine, flywheel/belt drive



HAMMOND REEF HERITAGE PHOTOGRAPHIC DOCUMENTATION



Plate S-17: Keighley Engine, east side; small steam engine



HAMMOND REEF HERITAGE PHOTOGRAPHIC DOCUMENTATION



Plate S-18: Small steam engine west of Keighley Engine



HAMMOND REEF HERITAGE PHOTOGRAPHIC DOCUMENTATION



Plate S-19: Pulley block west of Keighley Engine

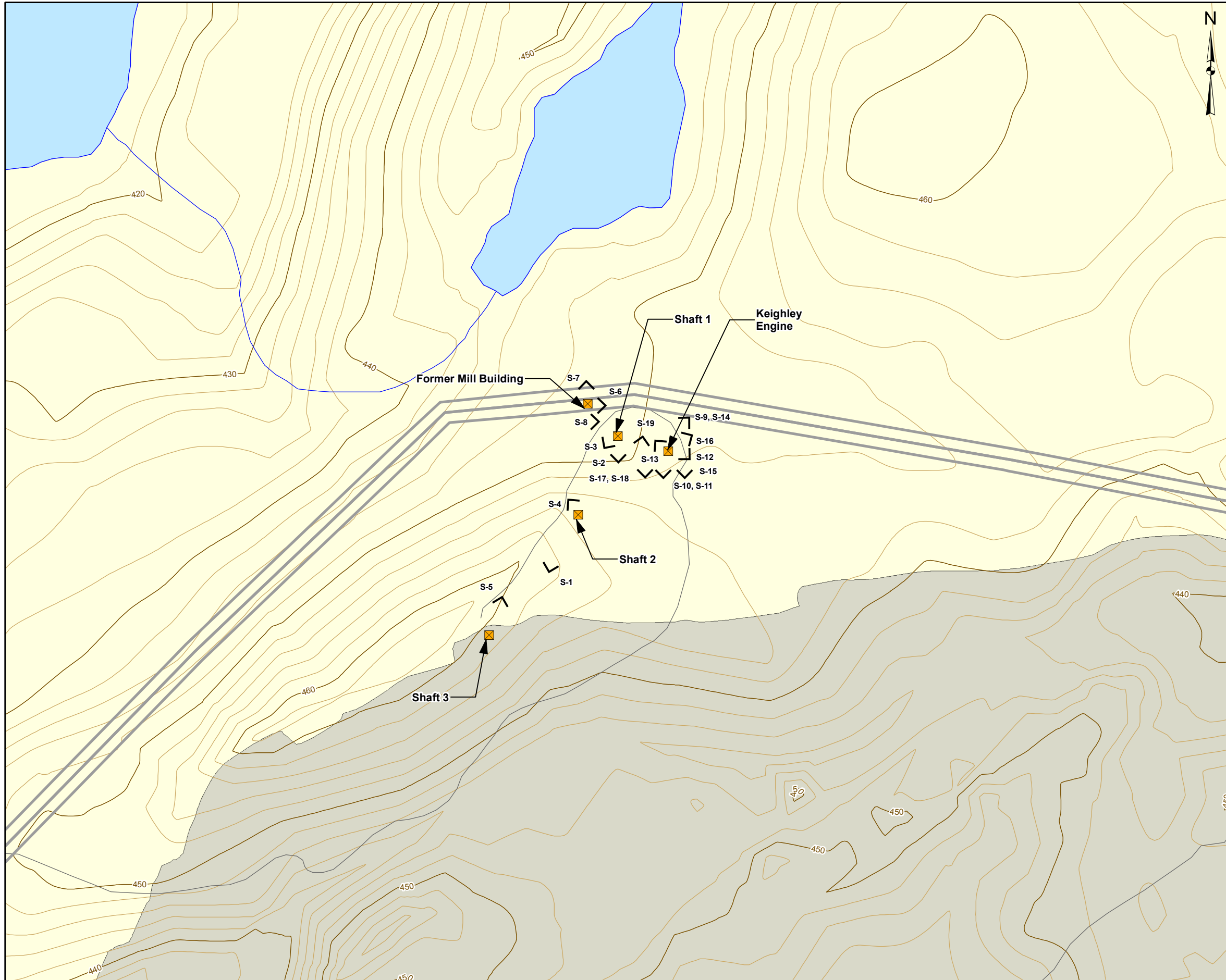

LEGEND

- Historic Mine Feature
- S-1 Photo Location and Direction
- Mine Site Road
- Road
- Contours - 10m interval
- Contours - 2m interval
- River/Stream
- Lake
- Mine Facilities

INDEX MAP

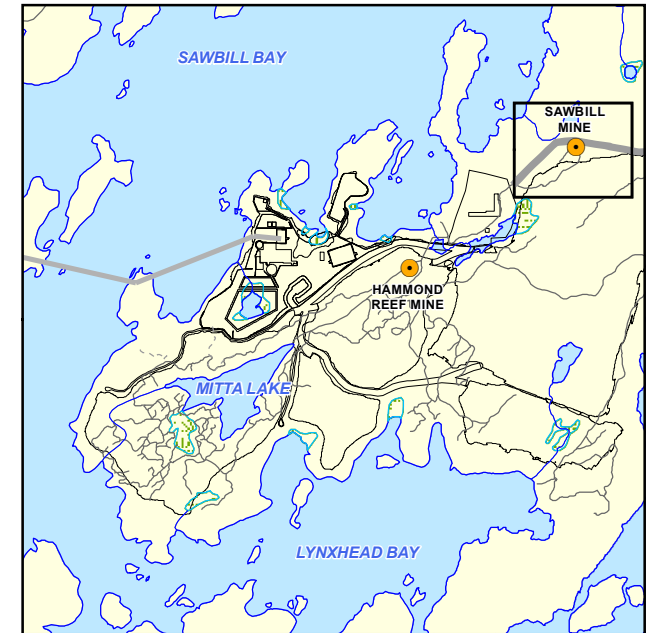

REFERENCE

Base Data - Provided by OSISKO Hammond Reef Gold Project Ltd.
 Base Data - MNR NRVIS, obtained 2004
 Produced by Golder Associates Ltd under licence from
 Ontario Ministry of Natural Resources, © Queens Printer 2008
 Projection: Transverse Mercator Datum: NAD 83 Coordinate System: UTM Zone 15N



PROJECT	HAMMOND REEF GOLD PROJECT ATIKOKAN, ONTARIO, CANADA		
TITLE	HISTORIC FEATURES - SAWBILL MINE		
Golder Associates Mississauga, Ontario	PROJECT NO:	1408383 (1300)	SCALE AS SHOWN
	DESIGN	CGE	14 Nov. 2008
	GIS	CGE	10 Dec. 2014
	CHECK	MG	10 Dec. 2014
	REVIEW	AA	10 Dec. 2014
MAP: 3			REV: 0



HAMMOND REEF HERITAGE PHOTOGRAPHIC DOCUMENTATION

Report Signature Page

GOLDER ASSOCIATES LTD.

<Original signed by>

Christopher Andreae
Senior Built Heritage Specialist

Michael Greguol
Junior Built Heritage Specialist

MG/CA/AA/sp

Golder, Golder Associates and the GA globe design are trademarks of Golder Associates Corporation.

\\golder.gds\gal\mississauga\active\2014\1188\1408383-cm-hammond reef ea follow-up\3100 - cultural heritage\doc005_heritage impact assessment\appendices\1408383_doc003_photographic documentation_rev 0_7apr2015.docx

As a global, employee-owned organisation with over 50 years of experience, Golder Associates is driven by our purpose to engineer earth's development while preserving earth's integrity. We deliver solutions that help our clients achieve their sustainable development goals by providing a wide range of independent consulting, design and construction services in our specialist areas of earth, environment and energy.

For more information, visit golder.com

Africa	+ 27 11 254 4800
Asia	+ 86 21 6258 5522
Australasia	+ 61 3 8862 3500
Europe	+ 44 1628 851851
North America	+ 1 800 275 3281
South America	+ 56 2 2616 2000

solutions@golder.com
www.golder.com

Golder Associates Ltd.
6925 Century Avenue, Suite #100
Mississauga, Ontario, L5N 7K2
Canada
T: +1 (905) 567 4444





**HERITAGE IMPACT ASSESSMENT
HAMMOND REEF GOLD PROJECT**

APPENDIX B

Options for Mitigation of Heritage Impacts



TECHNICAL MEMORANDUM

DATE April 7, 2015

PROJECT No. 1408383

DOC NO. 004 (Rev 0)

TO Cathryn Moffett
Canadian Malartic Corporation

CC Adam Auckland, Ken De Vos

FROM Christopher Andreae

EMAIL Christopher_Andreae@golder.com

OPTIONS FOR MITIGATION OF HERITAGE IMPACTS – HAMMOND REEF GOLD PROJECT

1.0 INTRODUCTION

1.1 Background

In 2014, Canadian Malartic Corporation (formerly Osisko Hammond Reef Gold) retained Golder Associates Ltd. (Golder) to complete a *Heritage Impact Assessment* (HIA) to evaluate the potential impact of the Hammond Reef Gold Project on heritage resources located within the Project area and to develop mitigation options to minimize adverse effects of the proposed undertaking. The heritage resources located within the Project area consist of two historic mine properties, the Sawbill Mine and the Hammond Reef Mine. The HIA recommended the following activities prior to further mine development in the vicinity of the two historic mine sites:

- The properties should be photographically documented by qualified individual(s) and the documentation should be deposited with local libraries;
- The location of historical mining features should be plotted on a map so that their locations can be considered as the design of the Project facilities (with the objective being to avoid disturbing the features if possible); and
- A heritage interpretation plan should be developed as a partnership between Canadian Malartic and local and regional institutions.

The photo documentation programme was undertaken in the fall of 2014 and a draft *Hammond Reef Heritage Photographic Documentation* report, including maps of the historical mining features, was submitted to Canadian Malartic in December 2014, (Golder 2014b). This *Technical Memorandum* presents possible concepts for conservation options and interpretation programs based on:

- The findings of the HIA and the photographic documentation programme; and
- Information obtained from a meeting with the Atikokan Museum Committee (October 22, 2014) and subsequent correspondence with the museum curator.

Golder Associates Ltd.

6925 Century Avenue, Suite #100, Mississauga, Ontario, Canada L5N 7K2
Tel: +1 (905) 567 4444 Fax: +1 (905) 567 6561 www.golder.com

Golder Associates: Operations in Africa, Asia, Australasia, Europe, North America and South America



A report, *Cultural Plan For Atikokan*, prepared for the Town of Atikokan in 2012 by Hume Communications provided a municipal context for an expanded museum facility as a cultural opportunity for the town. The *Plan* noted that “*broadening and enhancing cultural opportunities makes a community a more appealing place to live for young families (who are likely involved in the mining industry or other resource extraction industries). This helps to strengthen the community, its assessment base and its quality of life.*”

1.2 Organization

Section 2.1 of this *Technical Memorandum* pertains to the management of artifacts at the Mine Site. Sections 2.2 and 2.3 identify cultural heritage assets which can be used to enhance urban amenity/tourism opportunities in Atikokan.

2.0 MITIGATION OPTIONS

2.1 On-site Artifacts

2.1.1 Keighley Engine Preservation/Interpretation

A large two-cylinder diesel engine (Figure 1), manufactured in England by the Keighley company is located on a rock knoll at the former Sawbill Mine and dates from 1936/37. The engine was the only intact artifact identified within the Hammond Reef Mine property. The engine is fastened to a concrete foundation and the machine is in very good condition.

The Keighley engine is located immediately north of the proposed waste-rock stockpile of the future mine operation. The planned access road to the mine will be adjacent to the engine. Once mining begins, relocation of the engine may be required to facilitate rock waste disposal or road construction.



Figure 1: Keighley Engine with exhaust manifold/pipe on left at Sawbill Mine (October 21, 2014)

Conservation Option 1: Abandon in place

The goal of this option would be to preserve the engine as a monument to the early 20th century gold mining era. The engine would be left *in-situ* until actual mining development is undertaken. If required to facilitate mine development, the engine could be relocated to a new foundation within the project development area to avoid being impacted by the mine development. The engine has been in the open for about 70 years and shows remarkably little corrosion. The cost of this option would be limited to the cost of relocating the engine, constructing a new footing and possibly a roof over the machine. It is assumed that this work could be undertaken by Canadian Malartic for a relatively low cost.

Conservation Option 2: Relocate to Atikokan Historical Park

The goal of this option would be to cosmetically restore the exterior of the engine and place it on outdoor public display in the Atikokan Historical Park as part of an interpretation program for mining. The engine would complement the other historic mining and logging equipment in the Park.

The other large pieces of equipment presently in the Historical Park were apparently restored by community volunteer labour. The Atikokan Museum Committee indicated that these volunteer skills may no longer exist. If skilled volunteers are not available, professional firms exist that could undertake the work. The cost of this option would be higher relative to Option 1 due to the longer transportation distance and the potential requirement to contract the restoration work. A nominal amount of \$10,000 is provided as an estimate but it would vary considerably depending on the degree of restoration undertaken.

2.1.2 Other Artifacts

The archaeological and built-heritage assessments of the property identified wood stove castings (Figure 2) and other small artifacts; as well as a large “equipment dump” of fragments of gold-milling equipment. The Atikokan Museum curator indicated that she might be interested in obtaining some of these artifacts for the museum collection.



Figure 2: “Hazelwood” Stove iron castings at Hammond Mine

The costs associated with the acquisition of artifacts for the museum would be mainly salvage and transportation costs and would be dependent on the quantity and size of the artifacts requested. It is assumed that these would be delivered by Canadian Malartic at some future time when heavy equipment is available on the property.

If Canadian Malartic is interested in pursuing this mitigation option, a tour of the Mine Site for the Museum Board should be arranged to identify what artifacts should be added to the museum collection.

2.2 Atikokan Museum Exhibits

There is almost no interpretation in the museum of the early gold mining era in the region. The existing mining exhibits at the museum focus primarily on the Steep Rock iron mine operation.

The cost for developing new exhibits can be highly variable depending upon availability of thematic research, condition of artifacts, labour, etc. A range of \$75 to \$300/ft² (\$800 to \$3,225/m²) should be assumed to prepare exhibits. A mining display for the museum is estimated at between 100 to 200 ft² (9 to 18.5 m²). Therefore the range of costs is between a low end of \$7,500 and a high end of \$60,000.

2.3 Historical Park

The Atikokan *Historical Park* (Figure 3) was completed in 1980. An inspection of the property by Golder in October 2014 showed that the Park contained a very good collection of mining (and logging) equipment. The Park appears to have been professionally designed and the interpretive panels are quite good. If the Museum decides to accept the Keighley Engine, the Park would be a logical location for the machine.



Figure 3: Historical Park showing displays and Centennial Museum in rear (Oct 22, 2014)

The landscaping and the condition of the artifacts have not been maintained over the last 30 years. The paths have become overgrown and the displayed equipment needs painting and other maintenance. If the Keighley

Engine or other artifacts from the Project development area are relocated to the Park, Canadian Malartic could also offer to undertake upgrades to the park such as refurbishing the trails with gravel or wood chips. Tree planting could also compliment the exhibits and create a more aesthetically pleasing visitor experience.

Refurbishing the main trail, approximately 100 metres, with gravel (3m wide; 150mm Granular A subgrade; wood edging) is estimated at \$22,500 (\$225.00/linear metre) or with wood chips at \$8,500 (\$85.00/linear metre). Deciduous trees (60mm cal.) are estimated at \$550.00 per tree and coniferous trees (175cm height) at \$440.00 per tree. Assuming 15 deciduous and 10 coniferous the cost would be approximately \$12,650. Other costs could include repainting historic artifacts, replacing degraded timber and the removal and disposal of the existing trail materials.

“An expansion and redesign of the Historical Park district, including a new Regional Parks office, expanded museum facility, new town dock and new public park amenities” was one of four *opportunities* identified in the *Cultural Plan for Atikokan (2012)*. This opportunity is a bigger project than just rejuvenating the heritage exhibits in the Park. Canadian Malartic may wish to consult with the Municipality regarding its long term objectives for the Park.

3.0 LIMITATIONS

This assessment did not determine what landscaping and museum design services are available in Atikokan. The estimates are based on the services being based in Thunder Bay and/or southern Ontario. The Museum does not have any defined plans for mining exhibits. Any plans to enhance the cultural heritage resources of the Historical Park will have to take into account broader municipal concepts for the Park as outlined in the *Cultural Plan (2012)*.

4.0 CLOSURE

We trust that the information provided in this memorandum meets your present requirements. Should you have any questions or concerns, please contact the undersigned.

Christopher Andrae
Senior Consultant - Built Heritage

CA/AA/sp

\\golder.gds\gal\mississauga\active\2014\1188\1408383-cm -hammond reef ea follow-up\3100 - cultural heritage\doc005_heritage impact assessment\appendices\1408383_doc004_mitigation plan revised_rev 0_7apr2015.docx

As a global, employee-owned organisation with over 50 years of experience, Golder Associates is driven by our purpose to engineer earth's development while preserving earth's integrity. We deliver solutions that help our clients achieve their sustainable development goals by providing a wide range of independent consulting, design and construction services in our specialist areas of earth, environment and energy.

For more information, visit golder.com

Africa	+ 27 11 254 4800
Asia	+ 86 21 6258 5522
Australasia	+ 61 3 8862 3500
Europe	+ 44 1628 851851
North America	+ 1 800 275 3281
South America	+ 56 2 2616 2000

solutions@golder.com
www.golder.com

Golder Associates Ltd.
6925 Century Avenue, Suite #100
Mississauga, Ontario, L5N 7K2
Canada
T: +1 (905) 567 4444

